

# Seal Coat and Surface Treatment Manual

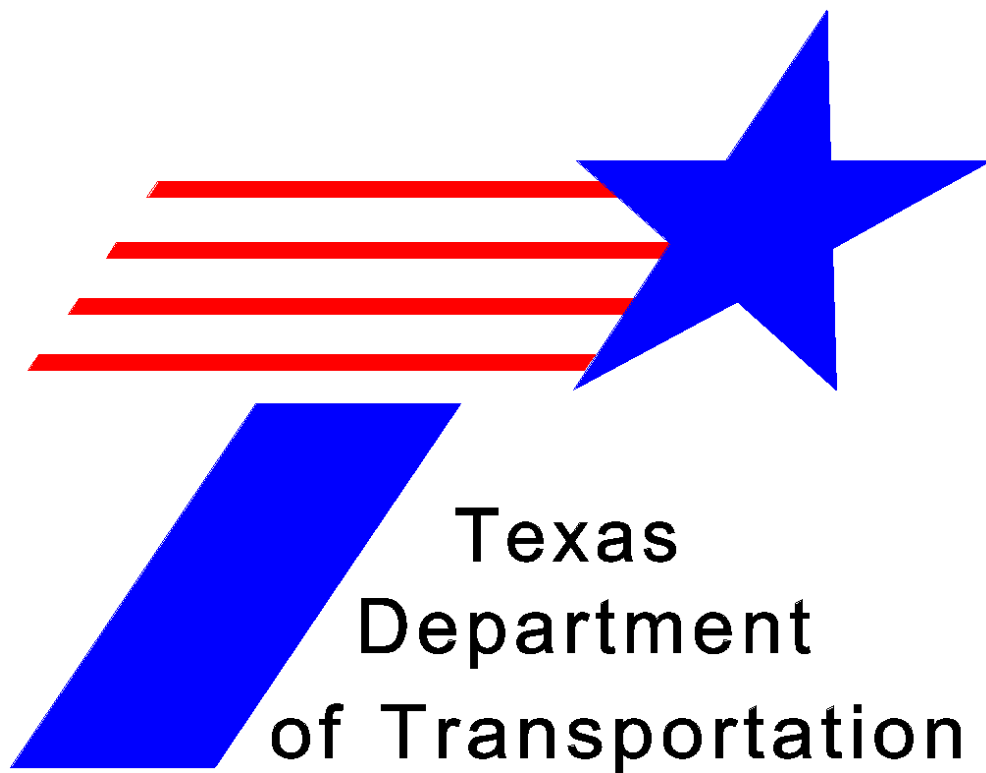

Texas  
Department  
of Transportation

Revised May 2010

© by Texas Department of Transportation  
(512) 416-2055 all rights reserved

## **Manual Notice 2010-1**

**From:** Zane L. Webb, P.E. Director, Maintenance Division

**Manual:** Seal Coat and Surface Treatment Manual

**Effective Date:** May 01, 2010

### **Purpose**

The *Seal Coat and Surface Treatment Manual* was revised to incorporate a recent TxDOT directive.

### **Changes**

Chapter 3, Sec. 4, Planning and Contracting: Added "To promote cost savings, a TxDOT directive states to limit seal coat on shoulders four feet or greater in width to every other seal coat cycle. Crack sealing on shoulders should be used as part of the overall maintenance plan and is a less expensive means of keeping water out of the substructure."

### **Contact**

Address questions concerning information contained in the Manual Notice to Randy Ormsby at (512) 416-3196.

### **Contact**

Address questions concerning information contained in the Manual Notice to Randy Ormsby at (512) 416-3196.

### **Archives**

Past manual notices are available in a [PDF archive](#).

---

# Table of Contents

## Chapter 1 — General Principles

Section 1 — Overview .....	1-2
General .....	1-2
Section 2 — Functions of Surface Treatments and Seal Coats .....	1-3
General .....	1-3
Section 3 — Factors Influencing Performance .....	1-5
General .....	1-5
Section 4 — Principal Faults or Defects in Seal Coats or Surface Treatments .....	1-6
General .....	1-6
Loss of Aggregate .....	1-6
Poor Adhesion or Bond to Road Surface .....	1-7
Streaking .....	1-8
Flushing .....	1-8

## Chapter 2 — Guidelines for Treatment Selection

Section 1 — Seal Coats as a Preventive Maintenance Technique .....	2-2
General .....	2-2
Section 2 — Selecting Pavements for Seal Coat Treatment .....	2-4
General .....	2-4
Pavement Distress Types .....	2-4
Section 3 — Traffic Volume Considerations for Seal Coat Treatment .....	2-5
Overview .....	2-5
Short-Term Aggregate Loss .....	2-5
Vehicular Damage .....	2-5
Tire Noise .....	2-6
Prolonged Traffic Control .....	2-6
Section 4 — Strip or Spot Sealing .....	2-7
General .....	2-7
Section 5 — Surface Treatments .....	2-8
General .....	2-8
Section 6 — Fog Seal .....	2-9
General .....	2-9

## Chapter 3 — Material Selection and Plan Preparation

Section 1 — Communication and Coordination .....	3-2
General .....	3-2
Section 2 — Selection of Binder .....	3-3
General .....	3-3

---

.....	3-4
Asphalt Cement .....	3-4
Cutback Asphalt .....	3-6
Emulsified Asphalt .....	3-8
Specification Tests .....	3-9
Weather Conditions .....	3-10
Section 3 — Selection of Aggregate .....	3-11
General .....	3-11
Factors of Aggregate Affecting Performance .....	3-11
Precoated Aggregate .....	3-13
Criteria for Determining Surface Aggregate Classification .....	3-13
Cost Considerations .....	3-14
Section 4 — Planning and Contracting .....	3-15
Calculate Quantities .....	3-15
Estimate of Materials .....	3-15
Preparing Plans .....	3-15
Estimating Cost .....	3-16

#### **Chapter 4 — Binder and Aggregate Application Rates**

Section 1 — Modified Kearby Design Method .....	4-2
General .....	4-2
Laboratory Tests .....	4-2
Determining Design Rates .....	4-2
Section 2 — McLeod Design Method .....	4-6
General .....	4-6
Design Procedure Components .....	4-6
McLeod Seal Coat Design Equations .....	4-10

#### **Chapter 5 — Duties of Inspector or Crew Chief**

Section 1 — Authority of Inspector .....	5-2
General .....	5-2
Inspection of Materials and Work .....	5-2
Section 2 — Duties of the Inspector or Crew Chief .....	5-3
General .....	5-3
Duties .....	5-3
Section 3 — Specifications and Plans .....	5-5
General .....	5-5
Standard Specifications .....	5-5
Special Specifications .....	5-5
Special Provisions .....	5-5

---

Plans . . . . .	5-5
Section 4 — Safety . . . . .	5-6
General . . . . .	5-6

**Chapter 6 — Pre-Seal Coat Activities**

Section 1 — Overview . . . . .	6-2
General . . . . .	6-2
Section 2 — Repairs and Patching . . . . .	6-3
General . . . . .	6-3
Timing . . . . .	6-3
Types of Repairs . . . . .	6-3
Section 3 — Stockpiling Aggregate . . . . .	6-5
General . . . . .	6-5
Supplier . . . . .	6-5
Aggregate Sampling and Testing . . . . .	6-5
Stockpile Locations . . . . .	6-5
Contamination . . . . .	6-6
Area Preparation . . . . .	6-6
Proper Stockpile Techniques . . . . .	6-6
Section 4 — Preconstruction Meeting . . . . .	6-8
General . . . . .	6-8
Meeting Objectives . . . . .	6-8
Attendees . . . . .	6-9

**Chapter 7 — Equipment Inspection**

Section 1 — Introduction . . . . .	7-2
General . . . . .	7-2
Provisions for Inspection . . . . .	7-2
Inspecting for Leaks . . . . .	7-2
Safety . . . . .	7-3
Section 2 — Rotary Broom . . . . .	7-4
General . . . . .	7-4
Identifying Data . . . . .	7-4
Safety Markings . . . . .	7-5
Bristles . . . . .	7-5
Brush Controls . . . . .	7-5
Older Model Brooms . . . . .	7-5
Section 3 — Asphalt Distributor . . . . .	7-6
General . . . . .	7-6
Asphalt Binder Tank . . . . .	7-7

---

Distributor Heating System .....	7-9
Distributor Circulation and Pumping System .....	7-10
Filter Screens .....	7-12
Distributor Spray Bar .....	7-13
Hand Sprayer .....	7-20
Distributor Controls and Gauges .....	7-21
Section 4 — Aggregate Spreader .....	7-25
General .....	7-25
Truck Hitch .....	7-26
Receiving Hopper .....	7-26
Belt Conveyors .....	7-27
Discharge Hopper .....	7-28
Discharge Gates .....	7-29
Discharge Roller .....	7-30
Wheels and Tires .....	7-30
Brakes and Clutch .....	7-31
Tailgate Aggregate Spreader .....	7-31
Section 5 — Haul Trucks .....	7-34
General .....	7-34
Size .....	7-34
Condition .....	7-34
Hoist .....	7-35
Tailgate .....	7-35
Hitch .....	7-35
Identifying Numbers .....	7-36
Bed Measurements .....	7-37
Volume of Truck Bed with Deduction for Hydraulic Ram Cover .....	7-37
Acceptable Size .....	7-38
Section 6 — Rollers .....	7-40
General .....	7-40
Identifying Data .....	7-40
Weight Certification .....	7-40
Pneumatic Rollers .....	7-40
Section 7 — Front-End Loader .....	7-45
General .....	7-45
Identifying Data .....	7-45
Visual Inspection .....	7-45
Section 8 — Heater and Storage Unit .....	7-46
General .....	7-46

---

Temperature . . . . .	7-46
Safety . . . . .	7-46
Storage Tank . . . . .	7-47
Heater . . . . .	7-47
Pump Unit . . . . .	7-47
Heater Unit Location . . . . .	7-47
Recording Thermometer . . . . .	7-48
Transporter and Booster . . . . .	7-48
Identifying Data . . . . .	7-48
Manifest . . . . .	7-48
Cleanliness . . . . .	7-49
Contamination . . . . .	7-49
Booster Tanks . . . . .	7-49
Insulation . . . . .	7-49

**Chapter 8 — Seal Coat/Surface Treatment Application Process**

Section 1 — Overview . . . . .	8-2
General . . . . .	8-2
Section 2 — Weather . . . . .	8-4
Introduction . . . . .	8-4
Temperature . . . . .	8-4
Humidity . . . . .	8-4
Wind . . . . .	8-5
Rain . . . . .	8-5
Section 3 — Traffic Control . . . . .	8-6
Introduction . . . . .	8-6
Pre-Positioning . . . . .	8-6
Displaying Signs . . . . .	8-6
Traffic Cones . . . . .	8-6
Flaggers . . . . .	8-7
Pilot Vehicle . . . . .	8-7
Repositioning Traffic Control Devices . . . . .	8-7
Intersections . . . . .	8-7
Arrow Boards . . . . .	8-8
Section 4 — Removing Pavement Markers . . . . .	8-9
General . . . . .	8-9
Section 5 — Cleaning the Pavement . . . . .	8-10
Introduction . . . . .	8-10
Safety During Sweeping Operations . . . . .	8-10
Sweeping Pattern . . . . .	8-10

---

Sweeping Distance from Operation . . . . .	8-10
Section 6 — Placing Temporary Tabs . . . . .	8-11
General . . . . .	8-11
Section 7 — Setting the Rock Lands . . . . .	8-12
Introduction . . . . .	8-12
Purpose . . . . .	8-12
Calculating the Length of Rock Land . . . . .	8-12
Marking the Rock Lands . . . . .	8-12
Section 8 — Setting the Asphalt Shots . . . . .	8-13
Introduction . . . . .	8-13
Asphalt Application Rate . . . . .	8-13
Distributor Capacity . . . . .	8-13
Calculating the Length of Asphalt Shot . . . . .	8-14
Marking the Asphalt Shot . . . . .	8-14
Section 9 — Checking the Loader Operation . . . . .	8-15
Introduction . . . . .	8-15
Loader Operation Checklist . . . . .	8-15
Section 10 — Placing Paper Joints . . . . .	8-16
Introduction . . . . .	8-16
Equipment . . . . .	8-16
Beginning of Asphalt Shot . . . . .	8-16
End of Asphalt Shot . . . . .	8-16
Subsequent Asphalt Shots with Multiple Distributors . . . . .	8-17
Section 11 — Shooting the Asphalt . . . . .	8-19
Introduction . . . . .	8-19
Distributor Preparation . . . . .	8-19
Blow the Nozzles . . . . .	8-20
Check Spray Bar Height . . . . .	8-21
Final Equipment Check . . . . .	8-21
Paper Joint Check . . . . .	8-21
Transverse Alignment . . . . .	8-21
Applying the Asphalt . . . . .	8-22
Timing for Aggregate Application . . . . .	8-22
Additional Distributors . . . . .	8-22
Section 12 — Strapping the Distributor . . . . .	8-23
Introduction . . . . .	8-23
Determining Asphalt Application Rate . . . . .	8-23
Section 13 — Spreading the Aggregate . . . . .	8-25
Introduction . . . . .	8-25



---

Aligning the Spreader Box .....	8-25
Truck Hookup .....	8-25
Test Strip .....	8-26
Spreading the Aggregate .....	8-26
Truck/Spreader Separation .....	8-26
Rock Land Marker .....	8-26
Visual Checks .....	8-27
Recording Truck Loads .....	8-27
Asphalt on Tires .....	8-27
Section 14 — Timing for Aggregate Application .....	8-29
Introduction .....	8-29
Immediate Aggregate Application .....	8-29
Section 15 — Rolling the Aggregate .....	8-31
Introduction .....	8-31
Rolling Pattern .....	8-31
Checking the Rolling Pattern .....	8-32
Section 16 — Patching or Hand Work .....	8-33
Introduction .....	8-33
Immediate Repairs .....	8-33
Delayed Repairs .....	8-33
Section 17 — Intersections and Irregular Shapes .....	8-34
Introduction .....	8-34
Transitions .....	8-34
Radii at Intersections .....	8-34
Crossovers on Divided Highways .....	8-34
Driveways and Private Roads .....	8-34
Problems with Hand Work .....	8-34
Section 18 — Brooming Excess Aggregate .....	8-35
Introduction .....	8-35
Timing .....	8-35
Equipment .....	8-35
Procedures .....	8-35
Inspection .....	8-35
Section 19 — Opening to Traffic .....	8-36
Introduction .....	8-36
Traffic Volume .....	8-36
Truck Traffic .....	8-36
Traffic Speed .....	8-36
Asphalt Type and Weather Conditions .....	8-36

---

Changing Lanes . . . . .	8-37
Section 20 — Temporary or Permanent Pavement Markings. . . . .	8-38
General. . . . .	8-38
Temporary Markings . . . . .	8-38
Permanent Markings . . . . .	8-38
Section 21 — Placing Raised Pavement Markers. . . . .	8-39
General. . . . .	8-39
Section 22 — Cleanup. . . . .	8-40
Joint Paper . . . . .	8-40
Spilled Asphalt . . . . .	8-40
Stockpile Area . . . . .	8-40
Signs and Barricades . . . . .	8-40
Repairs to Damaged Property . . . . .	8-40

**Chapter 9 — Public Perception and Complaints**

Section 1 — Handling Complaints . . . . .	9-2
General. . . . .	9-2
Section 2 — Public Perception and Education . . . . .	9-3
General. . . . .	9-3

# Chapter 1

## General Principles

### Contents:

[Section 1 — Overview](#)

[Section 2 — Functions of Surface Treatments and Seal Coats](#)

[Section 3 — Factors Influencing Performance](#)

[Section 4 — Principal Faults or Defects in Seal Coats or Surface Treatments](#)

## Section 1

### Overview

#### General

[Seal coats](#), also known as chip seals, are simple, relatively inexpensive pavement surfaces that are highly effective if adequate care is taken in the planning and execution of the work. A seal coat is an application of a layer of [asphalt binder](#) covered with a layer of [aggregate](#) applied to an existing paved surface. TxDOT spends close to \$180 million maintaining 186,600 lane miles of roadway, and seal coats are a very important part of TxDOT's preventive maintenance program. Some seal coats are placed by state forces, but the majority are placed by contract as shown below:

Year	Contracted Seal Coat, lane-miles	State Force Seal Coat, lane-miles
1999	10,950	3410
2000	17,740	3035
2001	17,350	2850
2002	16,665	2990

The average life of a seal coat or surface treatment is about six to eight years; however, some have performed successfully for periods of up to 20 years.

TxDOT specification Item 316, *Surface Treatments*, defines an application of asphalt material covered with a single layer of aggregate as a surface treatment. For purposes of this manual, an application of asphalt material covered with a single layer of aggregate when applied to a prepared compacted base is a surface treatment; whereas, a seal coat is applied to a paved surface.

This manual is intended to provide guidelines for the design, construction, and inspection of seal coats and surface treatments for contract and state force work. Both full-width seal coats/surface treatments as well as strip/spot seal coats are addressed. The manual is directed primarily to office and field engineers, laboratory personnel, and field inspectors.

---

## Section 2

### Functions of Surface Treatments and Seal Coats

#### General

A surface treatment is placed on a crushed stone base to provide a roadway with the least expensive permanent type of [bituminous](#) surface. It seals and protects the base and provides strength at the road surface so that the base can resist the abrasive and disruptive forces of traffic. It also provides many of the functions that a seal coat provides.

When applied to a bituminous pavement surface, a seal coat provides a durable all-weather surfacing that:

- ◆ seals an existing bituminous surface against the intrusion of air and water
- ◆ enriches an existing dry or raveled surface
- ◆ arrests the deterioration of a surface showing signs of distress
- ◆ provides a skid-resistant surface
- ◆ provides the desired surface texture
- ◆ improves light-reflecting characteristics where these are required (by use of light-colored stone)
- ◆ enables paved shoulders or other geometric features to be demarcated by providing a different texture or color
- ◆ provides a uniform-appearing surface.

The functions of the asphalt binder are to bind the aggregate particles to the underlying surface and to provide a waterproof seal. The functions of the aggregate are to resist traffic abrasion, to transmit wheel loads and to provide skid-resistance and the desired surface texture.

A seal coat or surface treatment has little or no structural strength itself but by preventing the ingress of water it enables the inherent strength of the pavement and the [subgrade](#) to be preserved. If a pavement shows evidence of traffic load associated cracking ([alligator](#), [longitudinal](#), transverse), a seal coat is only a temporary solution. Areas that show load-associated cracking may require base repair prior to a seal coat or overlay. A thick asphalt concrete overlay or reconstruction is normally required to correct these problems. Seal coats applied to pavements showing signs of non-traffic load associated longitudinal and transverse cracks have proved somewhat effective. Seal coats usually bridge these cracks in a more satisfactory manner than thin asphalt concrete overlays.

Ride quality of a pavement cannot be improved significantly by the application of a seal coat. Overlays of various thickness, spot level-up maintenance patches, or reconstruction are normally required to restore pavement ride quality.

Pavements demonstrating [flushing](#) or [bleeding](#) are difficult to repair with seal coats. The binder normally migrates through an added seal coat unless the asphalt quantity applied to the roadway can be altered at these spot locations. Seal coats utilizing a large maximum size aggregate are suggested if seal coats are used on flushed surfaces.

Seal coats have been used successfully on both low- and high-traffic volume roadways, but tend to be more successful on low-volume roadways, especially low-volume truck traffic. The use of seal coats in urban areas where accelerating/decelerating traffic and turning movements frequently occur should be approached with caution and is addressed more in Chapter 2.

## Section 3

### Factors Influencing Performance

#### General

The performance of seal coats and surface treatments depends on:

- ◆ construction techniques used
- ◆ properties of the bituminous binder and the stone
- ◆ amounts of stone and binder used and the uniformity of application
- ◆ development of good adhesion initially which must be maintained throughout the life of the surfacing
- ◆ development of a dense interlocking mosaic of stone
- ◆ strength of the underlying base or condition of underlying pavement
- ◆ amount and type of traffic
- ◆ environmental and drainage conditions.

These factors will be discussed in more detail later in this manual.

## Section 4

### Principal Faults or Defects in Seal Coats or Surface Treatments

#### General

Some of the most serious defects in seal coats and surface treatments are:

- ◆ loss of aggregate
- ◆ [streaking](#)
- ◆ flushing.

#### Loss of Aggregate

There are several major causes for serious loss of cover aggregate from surface treatments and seal coats as shown in Figure 1-1:

- ◆ A long delay between spraying binder and spreading cover aggregate, causing the binder to become chilled and hardened.
- ◆ Sealing too late in the season. Seal coats tend to perform better if they are under traffic a few months prior to winter weather.
- ◆ Insufficient binder is provided to cement the cover aggregate into place.
- ◆ Selection of an improper binder for prevailing conditions.
- ◆ A coating of dust or film of moisture on aggregate particles affects the adhesion to the binder.
- ◆ Fast traffic is permitted before adhesion is fully developed.
- ◆ A rainstorm occurs prior to development of adhesion.
- ◆ Placement of too much aggregate may cause embedded aggregate to dislodge under traffic.





Figure 1-1. Seal coat pavement surface exhibiting aggregate loss.

### Poor Adhesion or Bond to Road Surface

The complete loss of a surface treatment or seal coat happens rarely and therefore is not listed as one of the major defects; nevertheless, it can occur. Poor bond between an existing surface and a seal coat placed over it may be due to the following:

- ◆ a film or layer of dust
- ◆ moisture in the old surface following wet weather
- ◆ low ambient temperature
- ◆ use of a binder that is too viscous at the time rock is applied
- ◆ any combination of these at the time the seal coat was laid.

In the case of a surface treatment on a granular base, potholes and smaller breaks may develop over poorly bonded areas from which traffic has removed the surface treatment. Unless attended immediately by maintenance crews when they first appear and are still small, these holes in the surface treatment may quickly become so numerous and so large that it is no longer economical to attempt to restore the surface by simple patching methods. A poor bond between the binder and the granular base that results in these breaks is usually due to pockets of dust or other fine material, or to areas with excess moisture that existed in the prepared surface, or to low temperatures when the surface treatment was constructed. Attempting to use a binder that is too viscous will also contribute to this type of failure through lack of bond to the road surface.

A prepared road base structure that is to be surfaced using the surface treatment concept should always be [primed](#) first. The asphalt in the prime should be compatible with the binder used to create the surface treatment. To determine compatibility, consult with the manufacturer of the prime material and surface treatment binder.

## Streaking

Streaking results when alternate longitudinal strips of a surface treatment or seal coat contain different quantities of binder, due to lack of uniformity of application of the binder inch by inch across the surface. The dark streaks which exist in this condition occur when there is not enough asphalt binder to hold the cover aggregate in place, and part of the cover stone has been torn out by traffic. These dark streaks are points of weakness at which the complete seal coat or surface treatment will wear away first under traffic. Streaking can reduce skid resistance, cause vehicle steering problems, and lead to a serious reduction in the normal life expectancy.

In addition to shortening the service life, streaking can be so pronounced that it interferes with the steering of a car on the road and can cause the vehicle to weave, thereby affecting the safety of traffic.

Some of the more common causes of streaking are mechanical faults, improper or poor adjustment, and careless operation of bituminous distributors. Another frequent cause is applying the bituminous binder at too low a temperature, so that it is not fluid enough to fan out properly from the nozzles on the spray bars.

Other common causes of streaking requiring mechanical correction are:

- ◆ operating with a portion of the spray nozzles partially or completely clogged (faulty strainers or absence of strainers is sometimes at least partly responsible for this)
- ◆ using spray nozzles of different sizes, different makes, and different rates of discharge in the same spray bar
- ◆ operating when some of the nozzles have not been set vertically and at the proper angle in the spray bar
- ◆ using damaged or badly worn spray nozzles
- ◆ employing spray bars in which the center-to-center spacing of the nozzles is not uniform.

## Flushing

Too much bituminous binder used during the construction of seal coats and surface treatments is one of the most common defects. Excess binder exudes upward onto the pavement surface and is the origin of the black and frequently sticky surface condition referred to as flushing, bleeding, or fattening up and which can lead to a loss of skid resistance. Figure 1-2 shows an example of a flushed seal coat surface.



*Figure 1-2. A Seal Coat Pavement Surface Exhibiting Flushing in the Wheelpaths.*

Every element in the finished highway (width, alignment, profile) satisfies both engineering and aesthetic demands, and yet the surface is the most obvious part of the structure. A poorly designed and constructed seal coat begins its service life with a blemished appearance and a surface that may have flushed so badly that it will exhibit a loss of skid characteristics. Consequently, the finished surface satisfies neither the artistic nor the basic engineering requirements that the public has a right to expect. This manual will provide guidelines on determining the correct binder application quantities.

The application of insufficient binder leads to a loss of aggregate, because not enough binder has been applied to cement the aggregate particles into place. Sometimes the surface on which a seal coat or surface treatment is applied is so open or porous that a large portion of the binder soaks into it. Not enough binder remains on top to hold the aggregate, and it can be easily dislodged by traffic.

In general, the use of too little binder occurs less frequently than the application of too much.

# Chapter 2

## Guidelines for Treatment Selection

**Contents:**

- Section 1 — Seal Coats as a Preventive Maintenance Technique
- Section 2 — Selecting Pavements for Seal Coat Treatment
- Section 3 — Traffic Volume Considerations for Seal Coat Treatment
- Section 4 — Strip or Spot Sealing
- Section 5 — Surface Treatments
- Section 6 — Fog Seal

## Section 1

### Seal Coats as a Preventive Maintenance Technique

#### General

TxDOT has had a formal preventive maintenance program since 1987. Seal coats are used extensively as a preventive maintenance technique for bituminous pavements throughout Texas. While routine maintenance can be characterized as a reactive process in which immediate repairs are made to existing distress, preventive maintenance treatments help to preserve a pavement and extend its useful performance life. This concept is illustrated in Figure 2-1. It is desirable in Texas to place seal coats on a 6 to 8 year cycle, but this is not always possible due to funding constraints.

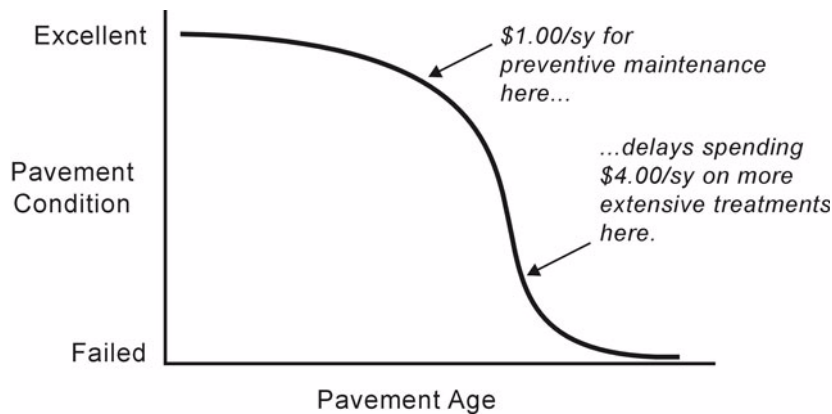

Figure 2-1. *The Concept of Preventive Maintenance.* (After Applied Pavement Technology, Inc., 1999)

The process for selecting pavements to receive seal coats will vary among the districts. In general, the process starts with maintenance section supervisors because they are most familiar with the roads in the section and inspect them often. They are also aware of the resurfacing and maintenance history of a roadway. The maintenance section supervisor generally prepares a list of candidate projects, and the list is reviewed and modified as appropriate by the area engineer before being submitted to the district office. Before the final selection is made by district staff, it is recommended that a designated person from the district office travel the roads to ensure they are good seal coat candidates.

Seal coats provide no additional structure to an existing pavement, so pavements that are structurally deficient are not candidates for seal coats. In addition, because wide cracks or cracks experiencing large movements are expected to reflect through the seal coat, pavements with extensive amounts of distress are generally not good candidates for a preventive maintenance treatment. There is, however, still a considerable amount of seal coat applied as a Band Aid to hold the pavement for a few years until reconstruction or rehabilitation can be funded.

In many cases, spot base repair, edge repair, crack sealing, strip/spot seal coat, or level-up work may be required to make an existing pavement ready to receive a seal coat and to maximize the life of the pavement.

Factors that can affect the decision to use a seal coat as a maintenance treatment include the following:

- ◆ condition of the existing pavement
- ◆ effectiveness of a seal coat in addressing the existing pavement deficiencies
- ◆ cost of the seal coat compared to other treatments
- ◆ traffic volume
- ◆ percent truck traffic
- ◆ repairs needed prior to the seal coat.

---

## Section 2

### Selecting Pavements for Seal Coat Treatment

#### General

The performance of a seal coat is, in part, governed by the structural adequacy of the underlying pavement layers. These underlying layers must possess the strength required to carry the wheel loads expected to use the facility, since the thickness of a seal coat will not add to the strength of the pavement layers. The seal coat acts mainly as a wearing course, sealing the road from the infiltration of surface water, and providing a skid-resistant surface.

#### Pavement Distress Types

A seal coat is applied to existing pavements for the overall purpose of extending the life of the pavement. A seal coat can correct minor surface deficiencies as described below:

**Cracking.** A seal coat will effectively prevent water from seeping through narrow surface cracks (1/8 inch or less) and damaging the base or underlying paved layers. Cracks wider than 1/8 inch should be crack sealed well ahead of seal coat placement.

**Raveling (or shelling).** Raveling is the condition in which aggregate particles in the old pavement have broken loose. A seal coat will generally cement the material in place and prevent additional raveling.

**Bleeding.** This is the condition in which excess asphalt in the existing pavement migrates to the surface. It appears as a black area and will reduce skid resistance. Placing a seal coat on top of a surface that is already bleeding may not correct this type of problem. Under the action of rolling and traffic, the aggregate from the new seal may become fully embedded into the bleeding asphalt surface. It may be possible to correct a bleeding surface with a seal coat if a larger maximum size aggregate (such as a Grade 3) is used. The void space in the larger rock layer may accommodate the excess asphalt.

**Lack of Skid Resistance.** A seal coat will bring angular aggregate particles into contact with vehicle tires to improve skid resistance. It is recommended that the accident history of a pavement be reviewed to determine if improved skid resistance is needed.

## Section 3

### Traffic Volume Considerations for Seal Coat Treatment

#### Overview

Although a seal coat can be applied to high-traffic volume roadways, it is generally limited to low-traffic volume roadways. Facilities with average daily traffic in excess of 10,000 vehicles per day will be considered as high traffic for purposes of this manual. Problems that can occur on high-traffic volume roadways are sometimes related to the following:

- ◆ short-term aggregate loss
- ◆ vehicular damage from loose aggregate
- ◆ potential for flushing
- ◆ tire noise
- ◆ prolonged traffic control.

Scott Shuler<sup>1</sup> (1990) offers several solutions to alleviate the impediments to using chip seals (seal coats) on high-volume facilities. Some of these solutions are discussed below.

#### Short-Term Aggregate Loss

Short-term aggregate loss refers to aggregate loss within hours or days after construction. If loss occurs within a few days, causes may be related to the following:

- ◆ binder too cold when aggregate applied
- ◆ inadequate binder quantity
- ◆ inadequate aggregate embedment
- ◆ existing pavement too cold when asphalt is applied
- ◆ cold weather immediately following construction.

#### Vehicular Damage

The potential liability due to vehicle damage from dislodged aggregate may be the primary reason for not using seal coats on high-traffic volume roadways. Damage can occur to windshields, headlights, radiators, and vehicle paint.

---

1. Shuler, T.S., 1990. "Chip Seals for High Traffic Pavements," *Transportation Research Record No. 1259*, Transportation Research Board, National Research Council, Washington D.C.



While there is sometimes a tendency to apply excess aggregate to avoid tracking by rollers, this excess aggregate can cause damage to vehicles. In addition, when more than one aggregate thickness is present, additional aggregate particles on the surface are pushed into those below. This action dislodges aggregate in the first layer causing loss of aggregate and changes in grading (due to aggregate crushing). The correct aggregate quantity should produce a layer, which is one-stone thick.

Allowing slow-moving traffic on a new seal coat after final rolling and sweeping is one of the best means to reduce premature aggregate loss. Slowly moving vehicles also seem to provide a level of aggregate orientation not achievable by conventional pneumatic rollers. One method to assure the traffic will move slowly is to use pilot vehicles. This practice is often not followed because of the inconvenience to motorists on high-volume facilities. To alleviate this problem, seal coat operations can be performed when traffic is at reduced levels.

The potential for vehicle damage can also be reduced by using a small aggregate size (such as a Grade 4) or by using lightweight aggregates which have a much lower specific gravity than conventional mineral aggregates.

## **Tire Noise**

The best seal coats are those that are effective sealing mechanisms and those that provide a long-lasting, high-friction riding surface. One of the ways to achieve these two objectives is by using large, one-sized aggregates (1/2 inch or greater). The larger aggregates require greater asphalt quantities to bind the aggregate that provides greater sealing capabilities while providing necessary friction. These larger aggregates often generate complaints by motorists because the tire noise level is greater. While the larger aggregates can increase the surface texture and improve friction, the key to friction is in the skid properties of the aggregate.

Double application seal coats (two-course surface treatment) using a smaller aggregate for the top layer will provide for less tire noise. This results in a first layer with more voids in the surface, while the second application of aggregate fills in the voids.

## **Prolonged Traffic Control**

Prolonged traffic control is primarily associated with emulsified asphalt binders. Increased traffic control is often necessary until the emulsion has had time to break and develop tensile strength to hold the aggregate.

Modified binders may offer a higher level of adhesion than corresponding conventional binders. Therefore, aggregate retention is better during the early life of the seal coat, and often the rigid levels of traffic control required for emulsions are not as significant when polymer-modified binders are used.

## Section 4

### Strip or Spot Sealing

#### General

Strip sealing or spot sealing is typically performed by maintenance forces. This type of maintenance treatment is used to address specific pavement conditions such as:

- ◆ longitudinal or transverse cracking
- ◆ early signs of alligator or block cracking
- ◆ flushing
- ◆ low skid resistance
- ◆ segregated spots in asphalt concrete.

It is critical that strip/spot seal work is done as soon as these specific conditions arise. If these conditions are not addressed quickly, they will degrade to the point that major repairs are needed.

Spot seal coats may be applied over spot base repairs or level-ups as an added measure of ensuring that no surface water penetrates into the base.

## **Section 5**

### **Surface Treatments**

#### **General**

A surface treatment is similar to a seal coat but differs in that it is placed on a prepared base as opposed to an existing paved surface. A surface treatment provides a durable all-weather surface that seals and protects the base and provides a wearing course.

Prior to placing a surface treatment, it is general practice to prime the base first. The prime penetrates the upper layer of the base creating a better binder-to-base bond; makes the base less permeable to air and water; and provides a dust-free surface that further improves the bond between the surface treatment and the base.

Surface treatments are used routinely in Texas for the riding surface on construction or reconstruction of low-traffic volume roadways. There are also many cases where surface treatments performed successfully on higher-traffic volume roadways. Since they provide a relatively thin wearing course, any imperfections in the finish to the base will be reflected through to the surface and will have an adverse effect on the riding quality of the roadway. Sometimes multiple surface treatments are used on the prepared base.

## Section 6

### Fog Seal

#### General

A fog seal is a light application of asphalt, usually emulsion, applied to retain aggregate. It is sometimes used over an asphalt concrete surface or a new seal coat, particularly if a porous aggregate has been used as the cover aggregate.

Sometimes a fog seal is used on an asphalt concrete surface that is exhibiting raveling. In some cases, a fog seal is applied to a seal coat that is exhibiting aggregate shelling. Aggregate shelling can often occur during the first cold spell after a seal coat. A light fog seal immediately applied at this time can minimize further shelling of seal coat aggregate.

Fog seals should be used with extreme caution as they can cause a temporary loss of friction on the roadway surface. Traffic should not be allowed on a fog seal until it has adequately cured.

# Chapter 3

## Material Selection and Plan Preparation

### Contents:

[Section 1 — Communication and Coordination](#)

[Section 2 — Selection of Binder](#)

[Section 3 — Selection of Aggregate](#)

[Section 4 — Planning and Contracting](#)

## Section 1

### Communication and Coordination

#### General

After roadways have been selected for seal coat application, communication and coordination must be established among the project design office, the area engineer, the maintenance supervisor, and other appropriate district personnel. Items to consider for discussion include the following:

- ◆ What are lessons learned from previous seal coat applications?
- ◆ What materials should be used?
- ◆ What suitable materials are currently on hand?
- ◆ How should repairs and patching be accomplished—contract or state force?
- ◆ What should be the time frame for completing all repairs?
- ◆ When will the seal coat be applied?

---

## Section 2

### Selection of Binder

#### General

All asphalts used in the United States are products of the distillation of crude petroleum. Asphalt is produced in a variety of types and grades ranging from hard and brittle solids to almost water-thin liquids. Asphalt cement is the basis of all of these products. It can be made fluid for spraying from an asphalt distributor by heating, by adding a solvent, or by emulsifying it. When a petroleum solvent, such as naphtha or kerosene, is added to the base asphalt to make it fluid, the product is called a cutback asphalt. When asphalt is broken into minute particles and dispersed in water with an emulsifier, it becomes an emulsified asphalt. The tiny droplets of asphalt remain dispersed until the emulsified asphalt breaks. All three of these forms (asphalt cement, cutbacks, and emulsions) may be used for seal coat and surface treatment work. However, the use of cutback asphalts has declined rapidly over the years due to concerns over air pollution and potential health risks as the solvents evaporate into the atmosphere.

According to the Asphalt Institute, asphalts for seal coats and surface treatments should have the following characteristics:

- ◆ When applied, the binder should be fluid enough to spray and cover the surface uniformly, yet viscous enough to remain in a uniform layer and not puddle in depressions or run off the pavement.
- ◆ After application, it should retain the required consistency to wet the applied aggregate.
- ◆ It should develop adhesion quickly.
- ◆ After rolling and curing, the binder should hold the aggregate tightly to the roadway surface to prevent dislodging by traffic.
- ◆ When applied in the proper amount, it should not bleed or strip under traffic or with changing weather conditions.

The bituminous binders used for seal coats and surface treatments should conform to TxDOT Standard Specification [Item 300](#), Asphalts, Oils, and Emulsions. Table 3-1 from Item 300 shows typical uses for different types of bituminous binders.

Table 3-1. Typical Material Use. (from Table 18 of Item 300 of TxDOT Standard Specifications)

**Table 3-1. Typical Material Use**

<b>Material Application</b>	<b>Typically Used Materials</b>
Hot-Mixed, Hot-Laid Asphalt Mixtures	PG Binders, Modified PG Binders, Asphalt-Rubber Types I and II
Surface Treatment	AC-5, AC-10, AC-5 w/2% SBR, AC-10 w/2% SBR, AC-15P, AC-15P, AC-15-5TR, HFRS-2, MS-2, CRS-2, CRS-2H, HFRS-2P, CRS-2P, Asphalt-Rubber Types II and III
Surface Treatment (Cool Weather)	RS-1P, CRS-1P, RC-250, RC-800, RC-3000, MC-250, MC-800, MC-3000, MC-2400L
Precoating	AC-5, AC-10, PG 64-22, SS-1H, CSS-1, CSS-1H
Tack Coat	RC-250, SS-1, SS-1H, CSS-1, CSS-1H, EAP&T
Fog Seal	SS-1, SS-1H, CSS-1, CSS-1H
Hot-Mixed, Cold-Laid Asphalt Mixtures	AC-0.6, AC-1.5, AC-3, AES-300, AES-300P, CMS-2, CMS-2S
Patching Mix	MC-800, SCM I, SCM II, AES-300S
Recycling	AC-0.6, AC-1.5, AC-3, AES-150P, AES-300P, Recycling Agent, Emulsified Recycling Agent
Crack Sealing	SS-1P, Polymer Mod AE Crack Sealant, Rubber Asphalt Crack Sealers (Class A, Class B)
Microsurfacing	CSS-1P
Prime	MC-30, AE-P, EAP&T, PCE
Curing Membrane	SS-1, SS-1H, CSS-1, CSS-1H, PCE
Erosion Control	SS-1, SS-1H, CSS-1, CSS-1H, PCE

### Asphalt Cement

Asphalt cements are classified based on their viscosity in poises (centimeter-gram-second units of dynamic viscosity) at 140°F. For example, if AC-5 or AC-10 is specified, the numerical value in these designations indicates the viscosity in hundreds of poises at 140°F. Additional letter designations such as “P” or “TR” as in AC-15P or AC-15-5TR indicate the presence of a polymer or (5 percent) tire rubber, respectively.

There are many requirements in the specifications for asphalt cements. The most important requirements are the viscosity, penetration, and aged viscosity. With these requirements we attempt



to control the temperature susceptibility (change of viscosity with change in temperature) of the asphalt and limit the amount of aging expected through the hot mix plant. We do not want an asphalt that gets too viscous at low temperatures or gets too fluid at high temperatures. We also don't want an asphalt which ages quickly in the hot mix plant. Although asphalt cements used for seal coats and surface treatments are not processed through a hot mix asphalt concrete plant, some test requirements were developed to consider the aging that occurs through the hot mix asphalt concrete plant. The main tests performed for asphalt cement and the reasoning behind them follow.

**Viscosity.** Viscosity is defined as a fluid's resistance to flow. The viscosity test is conducted at two temperatures, 140°F and 275°F. This test indicates how viscous the binder is at approximate maximum road temperatures (140°F) and its relative resistance to deformation (rutting) at summertime road temperatures. The limits on the high-temperature viscosity help ensure the asphalt does not get too fluid at high temperatures. An example of what to avoid is an asphalt that behaves like a wax. A wax will be stiff and hard at low temperatures, but as the temperature is raised, will soften and lose its stiffness.

At 140°F, there is a minimum and maximum viscosity required. At 275°F, there is only a minimum viscosity required.

**Penetration.** The standard penetration test indicates the relative stiffness of the asphalt at a temperature of 77°F.

The test measures the distance a standard needle weighted with a mass of 100 grams penetrates into the asphalt in 5 seconds. All testing takes place at a controlled temperature of 77°F.

The specification places a minimum on the penetration. The further the needle penetrates into the asphalt, the softer the asphalt.

**Temperature Susceptibility.** If there are limits on the viscosity at two different temperatures, and limits on the penetration, this will effectively limit the temperature susceptibility of the asphalt. (Remember temperature susceptibility is the change in viscosity with change in temperature.)

**Flash Point.** The flash point is defined as the lowest temperature at which application of a test flame causes the vapors above the surface of the liquid to ignite. This test is conducted for safety reasons. The test performed is the Cleveland Open Cup Flash Point as described in AASHTO Test Method T-48. An open cup of asphalt is heated at a specified rate. At temperature intervals, a small gas flame is passed over the surface of the asphalt. A minimum flash temperature is required for each type of asphalt cement.

**Solubility in Trichloroethylene (TCE).** In this test (AASHTO T-44), asphalt is dissolved in TCE and filtered. The insoluble material is weighed. This test places maximum limits on inorganic materials or carbon residues in the asphalt. These materials, if present, add no binding quality to the asphalt and are considered contaminants.

**Spot Test.** To conduct the spot test (Tex-509-C), a small amount of asphalt is dissolved in a solvent and dotted on a filter paper. A positive spot is seen as a ring of dark material deposited as the solvent-asphalt blend is absorbed and spreads out on the filter paper. This test is used to screen asphalts that age excessively in the Thin Film Oven Test (TFOT). Item 300 requires a negative result for the spot test. A positive spot indicates overheating during the manufacturing process.

**Specific Gravity.** Specific gravity is not a specification requirement but is a test performed to allow temperature-volume conversions in the field to ensure proper application rates. Specific gravity is the ratio of the mass of a given volume of material at 77°F to that of an equal volume of water at the same temperature.

**Thin Film Oven Test.** The Thin Film Oven Test (TFOT) is an aging test. This aging simulates the aging expected in the hot mix asphalt concrete plant.

**Viscosity of TFOT Residue.** The viscosity of the TFOT residue is measured to limit the aging of the selected asphalt to a threefold increase over the midpoint of the grade range at 140°F. As an example, AC-10 has a limit of  $3 \times 1000 = 3000$  poise.

**Ductility of TFOT Residue.** The TFOT residue is subjected to a ductility test. A dog bone-shaped specimen is cast and pulled apart at a standard speed and temperature in a water bath. The distance to rupture is measured. This test provides an empirical measure of the cohesiveness of the asphalt after aging. It is another limit on the stiffness of the asphalt after aging.

## Cutback Asphalt

Cutback asphalt is asphalt cement in which a solvent has been added. The addition of solvent will:

- ◆ allow seal coat work during cooler weather when an asphalt cement would cool and set too quickly
- ◆ make the binder used in the cutback more fluid
- ◆ allow application at lower binder temperatures.

The solvent functions as a carrier or application facilitator. After the application, the solvent evaporates leaving the asphalt cement. In this respect, the use of cutback asphalt is a poor use of solvents that could be used as fuels and these solvents may contribute to air pollution. For these reasons, TxDOT has continued to reduce the amount of cutback asphalt used in construction and maintenance operations.

There are two general types of cutback asphalt used by TxDOT: rapid curing (RC) and medium curing (MC). Rapid curing cutbacks contain a solvent in the gasoline-naphtha boiling range. Medium curing cutbacks contain a solvent in the kerosene boiling range. Since gasoline-naphtha is more volatile than kerosene, the solvent in rapid curing cutbacks evaporates faster than the solvent in medium curing cutbacks.

Heating asphalt binder always constitutes some degree of hazard. The most hazardous are cutback asphalts because of the highly volatile solvents used. Extreme care must be taken not to allow any spark or open flame to come in contact with the cutback asphalt or the gases from cutback asphalt due to the low flash point.

As in asphalt cements, rapid and medium curing cutbacks have a nomenclature that describes their solvent and viscosity. A cutback is designated as either RC (rapid curing) or MC (medium curing) to describe the solvent and a number from 30 to 3000 to describe the viscosity. The lower the number, the more solvent is contained in the product. MC-30 contains approximately 35 to 40 percent solvent while an MC-3000 contains only about 5 percent solvent.

RC cutbacks are primarily used for surface treatments on base courses and tack coats. MC cutbacks are primarily used for prime coats and surface treatments on base courses. The specification requirements for cutback asphalt focus on determining the type and amount of solvent used and the stiffness of the asphalt cement in the cutback.

**Viscosity.** The viscosity of the cutback is determined to ensure that the viscosity is in the range required by the specification. Viscosity of the cutback is critical to successful application. For instance, MC-30 is used for priming road base. The viscosity must be low enough that the cutback will penetrate (soak into) the base material. It must form a waterproof layer and enable successive asphalt layers to adhere to the base. Each grade of both MCs and RCs has its own viscosity limits.

**Flash Point.** Flash point is a safety related test. The procedure is similar to that of the asphalt cement. The container geometry is slightly different, but the result is the same. It provides an idea of the temperature at which one can expect the material to generate fumes that could ignite.

**Distillation.** The distillation test is performed for two reasons:

1. to examine the characteristics of the cutter stock used in the cutback manufacture
2. to examine the characteristics of the residue.

In the test, a sample of cutback asphalt is heated to 680°F. The initial boiling point and the amount of solvent collected at specified temperatures are measured. At 680°F, the remaining asphalt is removed from the heat source and poured into a can for further testing.

**Specific Gravity.** Specific gravity is not a specification requirement but is measured to allow for temperature-volume corrections in the field.

**Penetration/Ductility.** These tests are performed on the residue obtained from distillation. They are indicators of the stiffness and cohesiveness of the asphalt residue. They are performed using the same procedures described in the [Asphalt Cement](#) section.

## Emulsified Asphalt

Emulsified asphalt consists of asphalt cement droplets suspended in water. This dispersion, under normal circumstances, would not take place, since oil and water do not mix. If an emulsifying agent is added to the water, the asphalt cement will remain dispersed.

In the production of asphalt emulsion, water is mixed with an emulsifying agent and is pumped to a colloid mill along with asphalt. The colloid mill breaks the asphalt up into tiny droplets less than 5 microns in diameter. The emulsifying agent migrates to the asphalt-water interface and keeps the droplets from coalescing, because the asphalt droplets all carry the same electric charge. The emulsion is then pumped to a storage tank.

Emulsions are produced for ease of application. Emulsions enable much lower application temperatures to be used. Application temperatures range from 120°F to 160°F. This is much lower than the 275°F to 350°F used for asphalt cements. The lower application temperatures will not damage the asphalt and are much safer for field personnel.

After emulsion and aggregate have been applied to the road surface, the emulsion “breaks” leaving the asphalt cement holding the aggregate. The rate at which the asphalt globules separate from the water phase is referred to as the “breaking” or “setting” time. The rate of breaking is controlled primarily by the specific type and concentration of the emulsifying agent used, as well as atmospheric conditions.

The fact that different aggregate types have different rates of absorption means that breaking is also related to the relative absorption characteristics of the aggregate used. Those with higher absorption rates tend to accelerate the breaking of the emulsion due to the more rapid removal of water.

When the emulsion and the aggregate are oppositely charged, the initial break develops through the electrochemical charge between the emulsion and the aggregate. The main bond of strength between the asphalt film and the aggregate comes after the loss of water. The breaking or setting rate may be affected by the following factors:

- ◆ porosity of the aggregate
- ◆ moisture content of the aggregate
- ◆ weather conditions (temperature, humidity, wind)
- ◆ emulsion and aggregate temperature
- ◆ mechanical forces (traffic, rolling)
- ◆ cleanliness of aggregate
- ◆ type and amount of emulsifying agent
- ◆ intensity of charge on aggregate versus intensity of emulsifier charge.

Asphalt emulsions are divided into three categories: anionic, cationic, and non-ionic. In practice, only the first two are used for surface treatments and seal coats. The anionic and cationic classes refer to the electrical charges surrounding the asphalt particles. Cationic emulsions have a positive (+) electrical charge and anionic emulsions have a negative (-) electrical charge. Aggregates for use with emulsions should not be precoated because the precoating inhibits the chemical break, absorption, and adhesion of the emulsion to the rock. In general, cationic emulsions will break and set more quickly than anionic emulsions. In high humidity or cooler weather, cationic emulsions can break and set more quickly than anionic emulsions due to the electrochemical reaction between the aggregate and the binder in addition to evaporation of the water. Anionic emulsions tend to work well in low humidity or warm weather conditions.

Emulsions are named to describe their type, speed of break, and viscosity. A designation of “C” is used for cationic emulsions. Emulsions not using a “C” are anionic. Speed of break is designated by “RS” for rapid set, “MS” for medium set, and “SS” for slow set. The residue viscosity is designated by a number, usually a “1” or “2.” The “1” is a low viscosity emulsion used for such applications as fog sealing or cold weather applications where we want the emulsion to flow into cracks and crevices. The “2” is a high viscosity emulsion used for such applications as seal coats and surface treatments. If the number is followed by the letter “H,” the emulsion has a harder base asphalt. If the number is followed by the letter “P,” the emulsified asphalt contains a polymer. For example, CRS-2P is a cationic, rapid setting, high viscosity emulsion with polymer.

High-float (HF) emulsions, such as HFRS, have a quality that permits a thicker asphalt film on the aggregate particles and prevents drain-off of asphalt from the high points of the road surface.

Some properties of emulsions can be enhanced by the addition of polymers. Advantages of polymer-modified emulsions are:

- ◆ To increase the viscosity of the residual asphalt and thus minimize bleeding
- ◆ To maximize aggregate retention
- ◆ To enhance flexibility over time.

## Specification Tests

Tests for asphalt emulsions are devised to measure the emulsion properties, since these are the properties needed for handling and breaking, and the residual asphalt properties, since these will be the properties of the asphalt after break.

**Viscosity.** The viscosity of the emulsion is measured to determine uniformity and conformance to application needs. In the test a sample is brought to the test temperature (77°F or 122°F) and poured into the Saybolt viscometer. The flow of emulsion through an orifice into a flask of known volume is timed. When the flask is filled, the number of seconds is recorded and checked against specifications.

**Sieve Test.** This test measures the amount of foreign material or unemulsified asphalt in the emulsion. These materials can clog nozzles in a distributor truck and result in non-uniform application. A sample of emulsion is poured through a screen with specific opening sizes. Material retained on the screen is measured and expressed as a percent of the original emulsion.

**Demulsibility.** This test measures the stability of the emulsion (resistance to break) and distinguishes between RS, MS, and SS types. In the test a known amount of chemical (Calcium Chloride for anionic emulsions and Sodium Dioctyl Sulfosuccinate for cationic emulsions) is added to a specific amount of emulsion. The amount of emulsion that breaks is measured and reported as a percent of the amount of asphalt in the emulsion.

**Distillation.** In this test we measure the amount of asphalt in the emulsion and secure a sample of the residual asphalt for further testing. A known amount of emulsion is heated in a still to either 350°F or 500°F, depending on the requirements of each material. This heating drives off the water. The remaining asphalt is weighed to determine the asphalt content of the emulsion. The residual asphalt is poured into molds (penetration, ductility, or float) for further testing.

**Penetration.** The penetration of the residual asphalt is measured to determine stiffness. The procedure is identical to that of [asphalt cements](#).

**Ductility.** The ductility of the residual asphalt is measured to determine cohesiveness. Polymer-modified emulsions will get a low-temperature ductility measurement. The test procedure is identical to that for asphalt cement.

**Float Test.** The float test is a measure of the stiffness of the residual asphalt, but it is specifically designed to show the gel structure in a high float emulsion residue. A thimble-shaped mold with no top or bottom is filled with molten asphalt and allowed to cool. This mold is attached to a funnel-shaped float with the filled thimble plugging the hole in the funnel. This whole setup is floated in a 140°F water bath until the asphalt flows from the thimble and the float apparatus sinks. The number of seconds until sinking is reported.

## Weather Conditions

The weather conditions in the location where the seal coat is to be placed must be evaluated to determine the proper binder and aggregate combination. Considerations should be given to the following:

- ◆ extremely hot weather, which will lower viscosity and reduce cohesion of the binder
- ◆ cool weather during or after seal coat placement, which may result in a hardening of the binder and loss of aggregate
- ◆ uncertain weather in conjunction with varying temperature and/or humidity.

## Section 3

### Selection of Aggregate

#### General

The aggregate in a seal coat or surface treatment serves the following functions:

- ◆ It is resistant to the abrasion of moving wheel loads and transfers the wheel load to the underlying layers.
- ◆ It provides a skid-resistant surface.
- ◆ It may provide light-reflecting qualities.
- ◆ It may provide a different texture or color to distinguish areas, such as shoulders and travel lanes.

There are two broad categories used to describe the aggregates used in Texas for seal coats and surface treatments: natural and synthetic.

#### Natural Aggregates

- ◆ Crushed gravel – natural gravel that has been crushed to change the particle shape from round to angular and the surface from smooth to rough.
- ◆ Crushed stone – large stone or pieces of bedrock that have gone through a series of crushing processes. In Texas, this stone is predominantly limestone, but also includes sandstone.
- ◆ Natural limestone rock asphalt – limestone rock asphalt is a limestone that is naturally impregnated with asphalt.

#### Synthetic Aggregates

- ◆ Lightweight aggregate – expanded shale, clay, or slate produced by a rotary kiln method. Due to its low specific gravity (or light weight) it tends to cause less windshield and vehicle damage. It also has excellent skid-resistant properties.
- ◆ Crushed slag – produced as a by-product of steel production. When crushed and used as a seal coat aggregate, it can give good wear and skid resistance.

#### Factors of Aggregate Affecting Performance

##### Maximum Particle Size and Gradation

It is desirable that aggregates used for seal coats and surface treatments consist of essentially one size of aggregate. If all of the aggregate particles are about the same size, embedment depth will be the same for each particle contributing to successful performance of the seal coat. Very fine aggre-

gate particles are likely to become submerged in the asphalt. For practical purposes, specifications allow some oversize and some undersize particles. TxDOT Standard Specification Item 302, [Aggregates for Surface Treatments](#), describes the size and gradation requirements for aggregates used in seal coats and surface treatments.

The maximum particle size refers to the largest size allowable. For example, according to the specification, a Grade 3 aggregate has a maximum particle size of 5/8 inch, and a Grade 4 has a maximum particle size of 1/2 inch. A successful seal coat is more generally achieved when larger size cover aggregate is employed. This is because the larger aggregates are less sensitive to small variations in binder application rate than when smaller cover aggregates are used. Larger size aggregates, however, also tend to create more tire/pavement noise and are more likely to cause vehicle damage when dislodged from the pavement.

**Cleanliness.** If aggregate is excessively dirty or dusty, asphalt binder will not be able to hold the aggregate particles securely in place. The asphalt will stick to the coating of dirt or dust, and with traffic the aggregate particles will dislodge. The aggregate must also be free of foreign matter such as leaves, grass, sticks, and lumps of clay or dirt. Cleanliness is measured by the Deleterious Material Test (Tex-217-F, Part I) and the Decantation Test (Tex-406-A).

**Shape.** The ideal shape of aggregate particles for seal coats and surface treatments is a shape that is as near to cubical as possible. When the seal coat aggregate is in place, traffic gradually orients the particles until each is lying on its flattest side with its thinnest dimension generally perpendicular to the roadway surface. The average thickness of the seal coat when the aggregate particles attain this ultimate position is equal to the overall average of the thinnest dimensions of the stone particles. This overall average of the smallest dimensions of the particles is referred to as its Average Least Dimension (ALD). This ALD is important for two reasons:

1. It can control the quantity of cover stone and asphalt binder that should be applied.
2. ALD values can differ widely for any given maximum aggregate size due to particle shape.

The ALD will be discussed in more detail in Chapter 4. TxDOT specifications (Item 302, *Aggregates for Surface Treatments*) refer to the Flakiness Index, as measured in Test Method Tex-224-F, to control the aggregate shape. The lower the Flakiness Index, the more cubical the aggregate is.

Angularity is also an important shape characteristic. The more angular the stone, the better the interlocking because there are many points of contact. Angularity for crushed gravel is measured by the Coarse Aggregate Angularity Test (Tex-460-A, Part I).

**Toughness.** The aggregate must be able to resist abrasion and degradation. If the aggregate surfaces degrade under traffic, particles may break apart, broken pieces may dislodge (causing windshield damage), and flushing will likely result. These aggregate properties are measured by the Los Angeles Abrasion Test (Test Method Tex-410-A) and Magnesium Sulfate Soundness Loss (Test Method Tex-411-A).



**Aggregate Absorption (uncoated).** All aggregates are somewhat porous and will absorb water as well as asphalt. Limestone and lightweight aggregates are more absorptive than aggregates such as gravel. The amount of binder applied to the roadway should compensate for absorption into the cover aggregate. More absorptive aggregates also tend to have a higher affinity for asphalt (adhere better to the asphalt binder).

When aggregates are used that have a lower affinity for asphalt, extra care should be taken with respect to dryness and cleanliness of the aggregate, dry roadway surface, and dry weather.

### Precoated Aggregate

Aggregates may be precoated with asphalt binder to address the following issues:

- ◆ To maximize adhesion of the aggregate to asphalt cement binders
- ◆ To reduce or minimize the accumulation of dust on the surface of the aggregate
- ◆ To address the aggregate absorption quality of the aggregate
- ◆ To improve color contrast between striping and roadway surface.

Asphalt binders for precoating aggregates can be emulsions or asphalt cements. The target value of precoating material typically varies from 0.5 to 1.5 percent (0.5 to 3.0 percent for lightweight aggregate), by weight, of residual binder on the aggregate.

When the seal coat binder is to be an asphalt cement, precoating of the aggregate is recommended to maximize adhesion and reduce the adverse effect of dust. In general, precoated aggregate is not recommended when asphalt emulsions are used.

### Criteria for Determining Surface Aggregate Classification

The aggregates selected for use in seal coats or surface treatments should provide sufficient friction to satisfy the frictional demands of the roadway. The TxDOT Wet Weather Accident Reduction Program (WWARP) provides methods to ensure that pavements with good skid-resistant characteristics are constructed. The guidelines address three separate but interrelated aspects of pavement friction safety: accident analysis, aggregate selection, and skid testing.

For complete details on aggregate selection, refer to the TxDOT WWARP in the Pavement Design Manual. The designer should consider the guidelines presented in the WWARP and, using engineering judgment, determine the overall frictional demand of the roadway surface. TxDOT Standard Specification Item 316, [Surface Treatments](#), states “... unless otherwise shown on the plans, furnish aggregate with a minimum “B” (i.e., A or B is permitted) surface classification.”

### **Cost Considerations**

Another factor in selecting the aggregate is the cost of the material. Consider the desired life of the seal coat before deciding on the type and classification of aggregate. If the road is to be reconstructed/resurfaced in the near future or if the seal coat is to be applied as an underseal for a hot mix asphalt concrete (HMAC) overlay, higher quality/more expensive aggregate may not be necessary.

Some aggregates may not be available from local sources and will be more expensive due to transport costs. Aggregates such as lightweight aggregates and limestone may be more desirable due to certain qualities; but these aggregates may not be available from local sources.

---

## Section 4

### Planning and Contracting

#### Calculate Quantities

One of the first steps in the planning process is to determine the quantity of materials needed. This begins with determining how much roadway is to be covered.

The length and width of roadway to be seal coated must be determined to estimate material quantities. The length of the roadway should be obtained using the station numbers or a distance-measuring instrument (DMI).

Once the longitudinal distance has been determined, the area is computed by multiplying the longitudinal distance (length) by the width of the road, in feet. This total area will be expressed in square feet and must be converted to square yards by dividing the total area by 9. Asphalt application rates are expressed in gallons per square yard, and aggregate application rates are based on cubic yards (of aggregate) per square yard of roadway.

If different materials will be used on the shoulders, they should be calculated separately. To promote cost savings, a TxDOT directive states to limit seal coat on shoulders four feet or greater in width to every other seal coat cycle. Crack sealing on shoulders should be used as part of the overall maintenance plan and is a less expensive means of keeping water out of the substructure.

#### Estimate of Materials

An estimate of the material quantities can be made after the roadway area has been computed. It should be understood that the actual application rates of binder and aggregate should be based on a design procedure as described in Chapter 4 after aggregate is delivered and before construction starts. For planning purposes, it is only necessary to estimate the application rates of binder and aggregate. While the actual binder rate may vary in the wheelpath versus outside the wheelpath, and the binder/aggregate rate may vary in the travel lanes versus the shoulders, it is only necessary to use an overall average rate for estimating materials. Application rates for any binder and aggregate combination can vary considerably. The estimated application rates should be based on site-specific conditions and local experience.

#### Preparing Plans

For seal coat contracts, plans should include a title sheet, general notes, specification data, a summary of quantities, project location and limits, and standard sheets. Additional decisions regarding plan information may include the following:

- ◆ Any special site-specific requirements that need to be addressed?
- ◆ Any repairs and patching that need to be part of the project plans?
- ◆ Any “no-work areas” that need to be shown on plans including whether bridge decks are to be seal coated?

### **Estimating Cost**

For estimating seal coat contract costs, review previous unit bid prices and average unit bid prices. Average district and statewide unit bid prices can be obtained from the Construction Division’s (CST) monthly report for [construction and maintenance contracts](#). This report can be found through the TxDOT website.

# Chapter 4

## Binder and Aggregate Application Rates

### Contents:

[Section 1 — Modified Kearby Design Method](#)

[Section 2 — McLeod Design Method](#)

---

## Section 1

### Modified Kearby Design Method

#### General

The design method described in this section is based on a modification of the original Kearby method and was first recommended to TxDOT by Texas Transportation Institute in 1981 (Epps et al., 1981). It is still the method most commonly used by TxDOT today. A formal design method such as this can effectively serve to guide inexperienced personnel through the “art” of seal coat design and to train personnel including inspectors, designers, and laboratory personnel. Correction factors for binder application rates for varying conditions including traffic and surface condition may be developed for conditions unique to a district and will ensure a much faster learning curve for inexperienced personnel. Examples of some adjustment factors, which were developed by the Brownwood and Abilene districts, are shown in [Appendix A](#). Sample calculations are shown in [Appendix B](#).

A design method such as described herein should be used to determine initial binder and aggregate application rates, but it should not take the place of good engineering judgment. Field conditions will require the adjustment of both binder and aggregate rates.

#### Laboratory Tests

This design methodology requires the knowledge of some physical characteristics of the aggregate, such as unit weight, bulk specific gravity, and the quantity of aggregate needed to cover one square yard of roadway. Once the contractor has identified the aggregate to be used for the seal coat, samples of the stockpiled materials should be obtained to perform the following laboratory tests:

- ◆ Dry Loose Unit Weight—TxDOT Test Method Tex-404-A
- ◆ Bulk Specific Gravity—TxDOT Test Method Tex-403-A for all natural aggregate and Tex-433-A for lightweight aggregates
- ◆ Board Test—described below.

#### Determining Design Rates

**Aggregate Spread Rate.** The Board Test is used to find the quantity of aggregate on a board of known aggregate such that full coverage, one stone in depth, is obtained. A one-half square yard area is a convenient laboratory size. The weight of aggregate applied in this area is obtained and converted to units of pounds per square yard. Good lighting is recommended and care should be taken to place the aggregate only one stone deep. The quantity of aggregate needed to cover one square yard of roadway can also be determined in terms of volume as shown in Equation 4.1.

$$S = 27W/Q$$

Equation 4-1.

where:

- ◆ S = quantity of aggregate required in square yards per cubic yard (SY/CY);
- ◆ W = dry loose unit weight in pounds per cubic foot (lbs/CF); and
- ◆ Q = aggregate quantity determined from the board test (lbs/SY).

**Asphalt Application Rate.** The asphalt application rate for asphalt cement can be obtained from Equation 4.2 once the aggregate properties and existing roadway conditions are known.

$$A = 5.61E(1 - W/62.4G)T + V$$

Equation 4-2.

where:

- ◆ A = asphalt rate in gal/SY at 60°F
- ◆ E = embedment depth calculated using Eq. 3
- ◆ G = dry bulk specific gravity of the aggregate
- ◆ T = traffic correction factor (see Table 4-1)
- ◆ V = correction for surface condition (see Table 4-2).

$$E = e * d$$

Equation 4-3.

where:

- ◆ d = average mat depth in inches, as calculated from Eq. 4
- ◆ e = percent embedment expressed as a decimal from Figure 4-1.

$$d = 1.33Q/W$$

Equation 4-4.

where:

- ◆ Q = aggregate quantity determined from the board test in lbs/SY
- ◆ W = dry loose unit weight in lbs/CF.

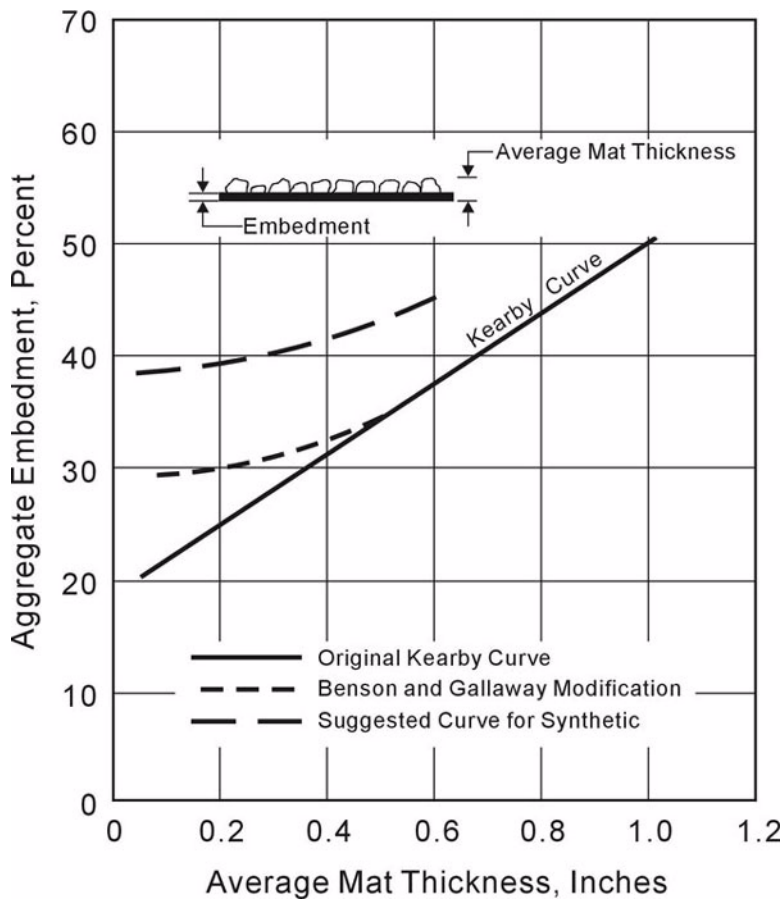

Figure 4-1. Relation of Percent Embedment to Mat Thickness for Determining Quantity of Asphalt. (After Epps et al., 1981)

Table 4-1. Asphalt Application Rate Correction for Traffic.

	Traffic – Vehicles per day per lane				
Traffic Correction Factor (T)	>1000	500-1000	250-500	100-250	<100
Traffic Correction Factor (T)	1.00	1.05	1.10	1.15	1.20

Table 4-2. Asphalt Application Rate Correction for Existing Pavement Surface Conditions.

Description of Existing Surface	Correction for Surface Condition (V), gal/SY
Flushing, slightly bleeding surface	-0.06
Smooth, nonporous surface	-0.03
Slightly porous, slightly oxidized surface	0.00
Slightly pocked, porous, oxidized surface	+0.03
Badly pocked, porous, oxidized surface	+0.06



These surface conditions may vary throughout the project, and adjustments should be made accordingly.

**Adjustment for Asphalt Emulsions or Cutbacks.** For emulsions, the application rate (A from Eq. 2) should be increased to take into account the water in the emulsion. Therefore, Equation 5 is presented to determine the recommended emulsion application rate. In theory, the asphalt cement rate from Eq. 2 can be converted to the required emulsion rate by dividing this amount by the residual asphalt present in the emulsion. However, field experience shows that if this value is utilized, flushing is likely to occur. Therefore, the recommended emulsion application rate is adjusted as shown below:

$$A_{recommended} = A + K(A_{theoretical} - A)$$

Equation 4-5.

where:

$A_{recommended}$  = recommended quantity of emulsion

A = asphalt application rate from Eq. 2

K = seasonal adjustment factor as shown below

$A_{theoretical}$  = theoretical quantity of emulsified asphalt, (A/R).

where:

R = percent residual asphalt in the emulsion expressed as a decimal. Check with supplier to determine percent residual asphalt content of emulsion.

Suggested K factors for emulsions are as follows:

K = 0.60 for spring construction

K = 0.40 for summer construction

K = 0.70 for fall construction

K = 0.90 for winter construction.

Suggested K factors for cutbacks are as follows:

K = 0.70 for spring construction

K = 0.60 for summer construction

K = 0.80 for fall construction

K = 0.90 for winter construction.

The K factors have not been verified by extensive controlled field experiments and therefore should only be used as a guideline.

Refer to Appendix B for a sample calculation.

## Section 2

### McLeod Design Method

#### General

In the late 1960s Norman McLeod (1969) presented the following design method which was later adapted by the Asphalt Institute (1979, 1983) and the Asphalt Emulsion Manufacturers Association (1981). In this method, the aggregate application rate depends on the aggregate gradation, shape, and specific gravity. The binder application rate depends on the aggregate gradation, absorption and shape, traffic volume, existing pavement condition, and the residual asphalt content of the binder. It should be noted that this method was developed primarily for use with emulsion binders and has not been verified in Texas.

The McLeod method is based on two basic principles:

1. The application rate of a given aggregate should be determined such that the resulting seal coat will be one-stone thick. This amount of aggregate will remain constant, regardless of the binder type or pavement condition.
2. The voids in the aggregate layer need to be 70 percent filled with asphalt for good performance on pavements with moderate levels of traffic.

#### Design Procedure Components

**Median Particle Size.** The Median Particle Size (M) is determined from the aggregate gradation chart. It is the theoretical sieve size through which 50 percent of the material passes. The following sieve sizes should be used:

Sieve Sizes
1 inch
$\frac{3}{4}$ inch
$\frac{1}{2}$ inch
inch
$\frac{1}{4}$ inch
No. 4
No. 8
No. 16
No. 50
No. 200

**Flakiness Index.** The flakiness index (FI) is a measure of the percent, by weight, of flat particles. It is determined by testing a sample of the aggregate particles for their ability to fit through a slotted plate (TxDOT Test Method Tex-224-F).

**Average Least Dimension.** The Average Least Dimension, or ALD (H), is determined from the Median Particle Size and the Flakiness Index. It is a reduction of the Median Particle Size after accounting for flat particles. It represents the expected seal coat thickness in the wheel paths where traffic forces the aggregate particles to lie on their flattest side. The ALD is calculated as follows:

$$H = \frac{M}{1.139285 + (0.011506)FI}$$

Equation 4-6.

where:

- ◆ H = Average Least Dimension, inches
- ◆ M = Median Particle Size, inches
- ◆ FI = Flakiness Index, percent.

**Loose Unit Weight of the Cover Aggregate.** The dry loose unit weight (W) is determined according to TxDOT Test Method Tex-404-A and is needed to calculate the voids in the aggregate in a loose condition. The loose unit weight is used to calculate the air voids expected between the stones after initial rolling. It depends on the gradation, shape, and specific gravity of the aggregate.

**Voids in the Loose Aggregate.** The voids in the loose aggregate (V) approximate the voids present when the stones are dropped from the spreader onto the pavement. Generally, this value will be near 50 percent for one size of aggregate, less for graded aggregate. After initial rolling, the voids are assumed to be reduced to 30 percent and will reach a low of about 20 percent after sufficient traffic has oriented the stones on their flattest side. However, if there is very little traffic, the voids will remain 30 percent, and the seal will require more binder to ensure good aggregate retention. The following equation is used to calculate the voids in the loose aggregate:

$$V = 1 - W/62.4G$$

Equation 4-7.

where:

- ◆ V = Voids in the loose aggregate, in percent expressed as a decimal
- ◆ W = Loose unit weight of the cover aggregate, lbs/ft<sup>3</sup>
- ◆ G = Bulk specific gravity of the aggregate (Tex-403-A for natural aggregates and Tex-433-A for lightweight aggregates).

**Aggregate Absorption.** Most aggregates absorb some of the binder applied to the roadway. The design procedure should be able to correct for this condition to ensure enough binder will remain on the pavement surface. McLeod suggests an absorption correction factor, A, of 0.02 gal/SY if the aggregate absorption is around 2 percent (as determined from Tex-403-A). In the Minnesota Seal Coat Handbook, it is recommended that a correction factor of 2 percent be used if the absorption is 1.5 percent or higher.

**Traffic Volume.** The traffic volume, in terms of vehicles per day, plays a role in determining the amount of asphalt binder needed to sufficiently embed the aggregate. Typically, the higher the traffic volume, the lower the binder application rate. At first glance, this may not seem correct. However, remember that traffic forces the aggregate particles to lie on their flattest side. If a roadway had no traffic, the particles would be lying in the same orientation as when they were first rolled during construction. As a result, they would stand taller and need more asphalt binder to achieve the ultimate 70 percent embedment. With enough traffic, the aggregate particles will be laying as flat as possible causing the seal coat to be as thin as possible. If this is not taken into account, the wheelpaths will likely bleed. The McLeod procedure uses Table 4-3 to estimate the required embedment, based on the number of vehicles per day on the roadway.

**Table 4-3. Traffic Correction Factor, T**

Traffic Factor*				
Traffic – Vehicles per day				
Under 100	100 to 500	500 to 1000	1000 to 2000	Over 2000
0.85	0.75	0.70	0.65	0.60
* The percentage, expressed as a decimal, of the ultimate 20 percent void space in the aggregate to be filled with asphalt.				

NOTE: The factors above do not make allowance for absorption by the road surface or by absorptive aggregate.

**Traffic Whip-Off.** The McLeod method also recognizes that some of the aggregate will get thrown to the side of the roadway by passing vehicles as the seal coat is curing. This loss is related to the speed and number of vehicles on the new seal coat. To account for this, a traffic whip-off factor (E) is included in the aggregate design equation. A reasonable value is to assume 5 percent for low volume, residential type traffic and 10 percent for higher speed roadways. The traffic whip-off factor is shown in Table 4-4.

**Table 4-4. Aggregate Wastage Factor, E\***

Percentage Waste Allowed for Traffic Whip-Off and Handling	Wastage Factor, E
1	1.01
2	1.02

**Table 4-4. Aggregate Wastage Factor, E\***

Percentage Waste Allowed for Traffic Whip-Off and Handling	Wastage Factor, E
3	1.03
4	1.04
5	1.05
6	1.06
7	1.07
8	1.08
9	1.09
10	1.10
11	1.11
12	1.12
13	1.13
14	1.14
15	1.15
*(Source: Asphalt Institute MS-19, March 1979).	

**Existing Pavement Condition.** The condition of the existing pavement plays a major role in the amount of binder required to obtain proper embedment. A new smooth pavement with low air voids will not absorb much of the binder applied to it. Conversely, a dry, porous and pocked pavement surface can absorb much of the applied binder. Failure to recognize when to increase or decrease binder application rate to account for the pavement condition can lead to excessive stone loss or bleeding. The McLeod method uses the descriptions and factors in Table 4-5 to add or reduce the amount of binder to apply in the field.

**Table 4-5. Surface Correction Factor, S.**

Existing Pavement Texture	Correction, S
Black, flushed asphalt surface	- 0.01 to - 0.06
Smooth, nonporous surface	0.00
Slightly porous, oxidized surface	+ 0.03
Slightly pocked, porous, oxidized surface	+ 0.06
Badly pocked, porous, oxidized surface	+ 0.09

These surface conditions may vary throughout the project, and adjustments should be made accordingly.

## McLeod Seal Coat Design Equations

The following equations are used to determine the aggregate and binder application rates. While the results may need adjustment in the field, especially the binder application rate, they have been shown to provide a close approximation of the correct material quantities.

**Aggregate Design Equation.** The aggregate application rate is determined from the following equation:

$$C = 46.8(1 - 0.4V)HGE$$

Equation 4-8.

where:

- ◆ C = Aggregate application rate, lbs/SY
- ◆ V = Voids in the loose aggregate, in percent expressed as a decimal (Eq. 7)
- ◆ H = Average least dimension, inches
- ◆ G = Bulk specific gravity of the aggregate
- ◆ E = Wastage factor for traffic whip-off (Table 4-4).

**Binder Design Equation.** The binder application rate is determined as follows:

$$B = \frac{2.244HTV + S + A}{R}$$

Equation 4-9.

where:

- ◆ B = Binder application rate, gal/SY
- ◆ H = Average least dimension, inches
- ◆ T = Traffic Correction Factor (based on vehicles per day, Table 4-3)
- ◆ V = Voids in loose aggregate, percent expressed as decimal (Eq. 7)
- ◆ S = Surface condition factor, gal/SY (based on existing surface, Table 4-5)
- ◆ A = Aggregate absorption factor, gal/SY
- ◆ R = Percent residual asphalt in the emulsion expressed as a decimal. Check with supplier to determine percent residual asphalt content of emulsion. For asphalt cement, R = 1.

# Chapter 5

## Duties of Inspector or Crew Chief

### Contents:

[Section 1 — Authority of Inspector](#)

[Section 2 — Duties of the Inspector or Crew Chief](#)

[Section 3 — Specifications and Plans](#)

[Section 4 — Safety](#)

## Section 1

### Authority of Inspector

#### General

An inspector serves as a representative of the project engineer. The project engineer has direct responsibility to ensure that all the work is performed in accordance with the contract that includes all plans, specifications, and other documents associated with the project. The engineer's decisions are final with regards to questions of quality or acceptability of materials furnished and work performed; the manner of performance and rate of progress; the interpretations of plans and specifications; and the acceptable fulfillment of the contract. Inspectors have the authority to enforce all the requirements of the contract, and they can shut the job down, if necessary. All the work, materials, and equipment on a project should be inspected. The contract and relevant plans, specifications, special provisions, and the work schedule should be thoroughly understood by the inspector. The Contract Administration Handbook [CCAM](#) and [Item 5](#) of the Standard Specifications provide more detail on the authority of the inspector.

#### Inspection of Materials and Work

Before any materials are used on a seal coat project, they must be sampled, inspected, tested, and approved by TxDOT. Inspection is also required in the preparation or manufacture of materials. Any work in which materials are used without prior testing and approval or written permission of the project engineer may be ordered removed and replaced.

Inspectors are authorized to inspect all work performed on the project. In the case of any dispute arising between the contractor and inspector regarding the work performed or materials furnished, inspectors have the authority to reject materials or suspend work until the issue can be resolved by the engineer.

The inspector is not authorized to revoke, alter, or release the contractor from any requirement of the contract. The inspector cannot approve or accept any portion of the work nor issue any instructions contrary to the plans and specifications. The inspector will not act as supervisor, perform other duties for the contractor, nor interfere with the contractor's management of the work.



---

## Section 2

### Duties of the Inspector or Crew Chief

#### General

Inspectors are responsible for verifying that all materials, equipment, and work meet the requirements of the specifications, special provisions, and plans. When seal coat work is performed by state forces, the crew chief has the responsibility of both the chief inspector and supervisor.

It is recommended that a seal coat project have a minimum of three people in the inspection team. The chief inspector should be well trained and experienced with all aspects of seal coat work. It is recommended that the same inspection team be used throughout the district each year to promote consistency and improve seal coat performance. The duties of the inspection team may be divided as shown below:

- ◆ Inspector 1 (Chief Inspector): Inspect the overall job, including traffic control, and determine the asphalt and aggregate application rates.
- ◆ Inspector 2: Monitor the binder application and control the rate based on instructions from the chief inspector.
- ◆ Inspector 3: Monitor the aggregate application and control the spread rate based on instructions from the chief inspector. Inspect the rolling operation.

Inspectors should report to the project engineer, usually through the chief inspector, concerning the progress of the work and the manner in which it is being performed. Any deviation from the plans or specifications must be brought to the attention of the chief inspector, engineer, and the contractor.

#### Duties

The inspector (or crew chief on state-force work) generally has the following duties:

- ◆ Thoroughly understand the specifications, special provisions, and plans prior to the beginning of the project.
- ◆ Ensure that aggregate stockpiles are adequate and are conveniently located.
- ◆ Ensure that asphalt storage heating facilities are adequate.
- ◆ Inspect all equipment to be used on the job.
- ◆ Sample both aggregate and asphalt materials as required.
- ◆ Monitor the temperature of the pavement surface, air, and asphalt binder.
- ◆ Adjust binder and aggregate application rates.

- ◆ Ensure the amounts of aggregate and asphalt used on the project are accurately recorded.
- ◆ Inspect the quality of the finished project and bring any deficiencies to the attention of the contractor and engineer.
- ◆ Ensure all reasonable precautions are taken to provide for the safety of the traveling public and all personnel involved in the project.
- ◆ Establish and maintain a professional working relationship with the contractor's personnel.
- ◆ Perform other duties as directed by the chief inspector, engineer, or their supervisor.

## Section 3

### Specifications and Plans

#### General

All aspects of a seal coat project must comply with the following contract documents:

- ◆ TxDOT's Standard Specifications for Construction and Maintenance of Highways, Streets, and Bridges (referred to in this manual as the Standard Specifications)
- ◆ Special Specifications
- ◆ Special Provisions
- ◆ Plans.

A complete listing of the particular requirements governing a seal coat project can be found in the contract documents.

#### Standard Specifications

Standard Specifications address the following:

- ◆ Quality of the materials and equipment
- ◆ Method and manner of work to be performed
- ◆ Method of measurement and payment.

The Standard Specifications are revised and updated periodically. It is important to ensure that the correct edition of the Standard Specifications is referenced. The Standard Specifications are also available online at <http://www.dot.state.tx.us/business/specifications.htm>.

#### Special Specifications

Special Specifications are supplemental specifications applicable to the individual project, not covered by the Standard Specifications.

#### Special Provisions

Special Provisions revise or supplement the Standard Specifications or Special Specifications.

#### Plans

The Plans (contract drawings) describe in detail the work to be accomplished.

## **Section 4**

### **Safety**

#### **General**

Inspectors and crew chiefs should refer to TxDOT's Occupational Safety Manual and the Handbook of Safe Practices to understand and follow all safety procedures applicable to seal coat work.

# Chapter 6

## Pre-Seal Coat Activities

### Contents:

[Section 1 — Overview](#)

[Section 2 — Repairs and Patching](#)

[Section 3 — Stockpiling Aggregate](#)

[Section 4 — Preconstruction Meeting](#)

## Section 1

### Overview

#### General

Seal coat projects take a great deal of planning and careful preparation to ensure that a seal coat job will last for many years. Numerous details must be worked out between the responsible engineer and the contractor. The engineer needs to know the approximate date the contractor plans to start the operation and who will supply the materials. The engineer must also arrange for the preconstruction meeting, which will be explained in detail in Section 4, [“Preconstruction Meeting”](#) of this chapter.

The main preparatory stages for a seal coat project include:

- ◆ Repairs and patching
- ◆ Stockpiling, sampling, and testing aggregate
- ◆ Preconstruction meeting
- ◆ Selecting application rates.

These preparatory stages will be discussed in detail in this chapter with the exception of selecting application rates, which are discussed thoroughly in Chapter 4, [“Binder and Aggregate Application Rates”](#)

---

## Section 2

### Repairs and Patching

#### General

Any repair work that the pavement needs should be done well ahead of seal coat work, ideally in the previous summer or fall. Certain repairs may involve a strip/spot seal coat or fog seal, reducing the amount of the future seal coat binder that is absorbed into the repair. Repairs are usually accomplished by TxDOT maintenance forces.

#### Timing

There is no absolute time frame during which repair work must be accomplished. It is generally preferred that all repair work be done as far as eight months prior to applying the seal coat. This is particularly true when repairs are performed using cold-laid asphalt mixes. This allows plenty of time for the materials to cure adequately prior to sealing. However, this means doing the repairs during the fall of the previous year. This may be practical in some regions of the state and not others.

If a fog seal is to be placed on a repaired area, the materials in the repaired area should be completely cured before a fog seal is applied. Fog sealing on pavement repairs can be placed anytime after the repair has cured and prior to seal coat work.

Repairs should be coordinated with the responsible maintenance personnel as far in advance as possible. This will enable them to plan schedules and needed materials accordingly.

#### Types of Repairs

Many different types of repairs may be required as described below.

**Milling or Planing.** High spots in the existing surface may be planed smooth with either a heater planer or, more commonly, a cold planer. This will help to smooth out a rough riding surface.

**Level-Up.** Depressions may require leveling up with either a hot- or cold-laid asphalt mix. The sizes of this type of patch will vary, of course, but may range from the size of a wheel path only a few feet in length to a full two-lanes wide and 50 feet or more in length.

**Pothole Repair.** All potholes must be repaired in a permanent manner before the seal coat is applied.

**Base Repair.** All base failures must be repaired before seal coat work. This may require an in-place repair or removal and replacement with suitable material.

**Edge Repair.** Raveled edges and edge drop-offs must be repaired. If vegetation and soil has built-up at the pavement edge, it must be removed and the pavement edge restored.

**Crack Sealing.** Large cracks must be sealed with a crack sealant. If they are excessively large, it may be necessary to cut them out and apply a hot or cold mix patch. Cracks this large, however, are not common in Texas, unless there has been a failure or distress in the base or subbase. In this event, the whole section must be removed, including the base or subbase, and completely rebuilt.



## Section 3

### Stockpiling Aggregate

#### General

TxDOT's Standard Specifications allow the contractor to stockpile aggregate to be used on the project at locations approved by the engineer. For the sake of efficiency, most contractors will elect to do this. There are, however, some steps that must be taken before stockpiles are placed on the job site.

#### Supplier

Before the contractor submits a bid on the project, he will have already received a tentative agreement from a supplier that the required materials will be made available. When the contract is awarded, the contractor identifies his supplier to the engineer.

#### Aggregate Sampling and Testing

The plans, specifications, and special provisions identify the required tests for the aggregate. Test methods are defined in TxDOT's [Manual of Testing Procedures \(2002\)](#). The sampling and testing locations and frequencies are in TxDOT's Construction Contract Administration Manual (2002), "[Guide Schedule of Sampling and Testing.](#)"

Item 6.1 of the Standard Specifications states, "All materials being used are subject to inspection or tests at any time during preparation or use. Any material which has been tested and accepted at the source of supply may be subjected to a check test after delivery, and all materials which, when re-tested, do not meet the requirements of the specifications will be rejected."

The method and location of sampling materials should be consistent and uniform. The AE can retest accepted materials if the material shows visible changes, does not conform to specifications, or if further testing is called for by the specifications or Guide Schedule. Construction Materials and Pavements (CST M&P) [Material Inspection Guide](#) contains additional material specific information on sampling and testing responsibilities.

#### Stockpile Locations

Normally, the contractor proposes the stockpile locations to the project engineer for approval. TxDOT Standard Specifications for surface treatments ([Item 316](#)) gives broad restrictions on stockpile locations as follows:

- ◆ 30 feet from roadway

- ◆ Should not obstruct traffic or sight distance
- ◆ Should not interfere with the access from abutting property
- ◆ Should not interfere with roadway drainage.

### **Contamination**

It is important for stockpiles to be placed so that they are not contaminated. Extreme care must be taken that clay and mud do not pose a problem. Stockpiling should not be situated such that roadway drainage will cause the aggregate to remain excessively wet.

### **Area Preparation**

If necessary, the Contractor may be required to prepare a stockpile area before the aggregate is placed on it. He may be required to level it with a dozer or motor grader, and to clear it of any debris, such as vegetation, rocks, and sticks. Appropriate storm water pollution prevention devices should be placed as necessary.

### **Proper Stockpile Techniques**

Stockpiles should be placed in a manner that will minimize (or prevent) segregation and degradation.

**Segregation.** The separation of the different sized aggregate particles. Segregation would result in one part of the stockpile containing only the coarser particles and another area containing only finer particles. Ideally, any sample taken from any area of the stockpile should contain a representative sampling of the complete range of sizes.

**Degradation.** The breaking apart of the aggregate particles. This, of course, would result in a finer gradation of aggregate than desired. Degradation occurs most commonly from improper operation of the front loader, rather than improperly constructed stockpiles. Figure 6-1 shows a properly placed stockpile. Note the series of loads that have been placed adjacent to each other. Stockpiles should not be placed in one high cone-shaped heap, because segregation is almost certain to occur.



*Figure 6-1. Properly Placed Aggregate Stockpiles.*

---

## Section 4

### Preconstruction Meeting

#### General

When all sampling and testing has been accomplished, and before work begins, it is necessary for the Contractor and his representatives to meet with TxDOT's representatives. During this meeting a "game plan" is developed and final details are worked out.

#### Meeting Objectives

Specifically, the preconstruction meeting should meet the following objectives:

**Meeting All Personnel Involved.** The preconstruction meeting allows the contractor and his foreman and supervisors to meet the project engineer, chief inspector, and the other project inspectors. This is sometimes the first time these two groups have ever met each other in person.

**Establish Working Relationship.** The preconstruction meeting provides an opportunity to establish a harmonious, yet professional working relationship between key personnel involved in the project. It is necessary for TxDOT personnel to be able to work in harmony with the contractor's personnel; otherwise, every day of the project can be agony. Yet, as representatives of the taxpayers of Texas, a professional image must be maintained.

**Define Responsibilities.** All project personnel must be aware of the chain of command or escalation ladder in the event of project-related conflicts.

**Define Work Schedule.** TxDOT and the contractor should agree on a work schedule that defines the roadways to be seal coated. General agreement should be reached on the sequence of lanes to be sealed, and any unique features should be discussed.

**Review Traffic Control.** Traffic control and handling must be discussed. It is critically important to ensure the safety of the traveling public during construction projects. Traffic handling methods, devices, signs, and barricades must be discussed in detail. Emphasis should be placed on the correct flagging procedures.

**Identify Work Days and Holidays.** By contract, a project must be completed within a specified number of days. The contractor should inform the engineer if he intends to work any weekends or holidays.

**Miscellaneous.** Any other pertinent information concerning the project should be discussed at this meeting. Both TxDOT and contractor's representatives should leave the meeting with a full understanding of the project.

---

**Attendees**

There is no specific rule as to who should attend the preconstruction meeting. The contractor should be represented by the project supervisor, foreman, and any other supervisory personnel on the project. It is highly recommended that the following TxDOT personnel attend (as a minimum):

- ◆ Project Engineer
- ◆ Area Engineer (s)
- ◆ Maintenance Supervisor (s)
- ◆ Director of Maintenance
- ◆ District Laboratory Engineer
- ◆ Inspectors.

If traffic is expected to be a major factor, sometimes the Department of Public Safety (DPS) will be represented. Occasionally, a representative of the local police department will attend, especially if the project is located in a major metropolitan area. This police inclusion is recommended.

Any other people who have a direct interest or responsibility in the project may be invited to attend. This may include the district public information and safety representatives, Federal Highway Administration personnel, and occasionally, a representative of the asphalt supplier, especially if a special binder is specified.

# Chapter 7

## Equipment Inspection

### Contents:

[Section 1 — Introduction](#)

[Section 2 — Rotary Broom](#)

[Section 3 — Asphalt Distributor](#)

[Section 4 — Aggregate Spreader](#)

[Section 5 — Haul Trucks](#)

[Section 6 — Rollers](#)

[Section 7 — Front-End Loader](#)

[Section 8 — Heater and Storage Unit](#)

## Section 1

### Introduction

#### General

Inspectors of seal coat work must be knowledgeable of the capabilities and limitations of the equipment. Equipment must be properly calibrated, well maintained, and functioning correctly to have a successful seal coat project.

This chapter will provide basic knowledge and general inspection procedures for the following typical types of equipment:

- ◆ Rotary broom
- ◆ Asphalt distributor
- ◆ Aggregate spreader
- ◆ Haul trucks
- ◆ Rollers
- ◆ Front-end loader
- ◆ Heater and storage unit.

A manufacturer's manual for each piece of equipment should be available on the project and consulted whenever specific questions arise.

#### Provisions for Inspection

The contractor and project engineer typically coordinate the starting date of the project, and set a date and time for the equipment to be assembled for inspection. It is advisable to set aside a minimum of half a day for equipment inspection at least one day before seal coat work begins. Initial equipment inspection should not be done the first hour or two of the morning the project begins. Even if all the equipment was functioning correctly on the last project, equipment problems can occur during the movement of the equipment. Plenty of time should be allowed to carefully inspect all equipment, and to allow more time to correct any discrepancies that are found.

#### Inspecting for Leaks

All equipment used on the project should be given a thorough visual inspection for leakage of any substance that might contaminate the asphalt, aggregate, or prevent adhesion to the pavement surface. These substances include fuel (both diesel and gasoline), hydraulic fluid, engine coolant, crankcase oil, and transmission fluid.

Inspecting for leaks is extremely important, not only before the project begins, but throughout the entire project. If a leak is detected in any piece of equipment, the equipment should be removed from the roadway until it is repaired.

## **Safety**

Follow the manufacturer's safety procedures for inspection and operation of all equipment.

Additional safety procedures should be followed for any equipment used for transporting, storing, or applying asphalt materials. Heating asphalt binder always constitutes some degree of hazard, with the exception perhaps of emulsions. The most hazardous are cutback asphalts because of the highly flammable solvents used. Extreme care must be taken not to allow open flames to come in contact with the asphalt or the gases from these materials. When working with asphalt cement, the major safety concern is related to the high temperature of the binder. Asphalt cement at 300°F can cause very severe burns. Avoid standing near the asphalt distributor during heating and operation unless necessary. It is recommended that a copy of the Material Safety Data Sheet (MSDS) for the binder being used be kept with the asphalt distributor truck. In addition, refer to TxDOT's Handbook of Safe Practices (1997) regarding asphalt heaters, distributors, and storage.



## Section 2

### Rotary Broom

#### General

The pavement must be adequately broomed before asphalt is applied. This must be performed thoroughly to ensure an adequate bond of the asphalt to the pavement. A finished seal coat will also be broomed to remove excess aggregate particles. Power rotary brooms are used for these purposes. An example of a rotary broom is shown in Figure 7-1. A vacuum sweeper is another type of broom which may also be used to clean the pavement.



Figure 7-1. Rotary Broom.

Rotary brooms for seal coat work should be self-propelled, four-wheeled, and capable of operating in both forward and reverse. They are powered by either a gasoline or diesel engine. The bristle brush should be capable of being raised, lowered, and rotated horizontally. The bristle brush on a rotary broom is shown in Figure 7-2.



Figure 7-2. Bristle Brush on Rotary Broom.

#### Identifying Data

As with other pieces of equipment, the manufacturer's name, model number, and serial number may be recorded and entered in the project folder. The inspector should record in the project diary that the equipment was inspected and found acceptable for use on the project.

## **Safety Markings**

The rotary broom, or sweeper as it is often called, operates well ahead of the rest of the equipment. This puts it in a very vulnerable position on many roads, due to its tendency to create dust and the exposure to traffic. Safety markings, lights, and flags must be in place on the broom and checked for the benefit of the traveling public as well as the sweeper operator.

## **Bristles**

The bristles may be nylon or fiber, or some may be a combination of nylon and steel bristles. The bristles on the sweeper should be checked to ensure they are in good condition. The width of the brush should be checked for evenness. If the bristles are worn off unevenly, too much pressure will be exerted in one spot and the bristles may not make contact in another. If there is a visible unevenness, the bristle assembly should be replaced.

## **Brush Controls**

The brush should be inspected to see that it can be raised and lowered and that it can be rotated horizontally. It should be capable of discharging aggregate to the left or right. The brush controls should start and stop the rotating promptly.

## **Older Model Brooms**

Some of the older types of brooms have a separate hydraulic cylinder at each end of the broom, which raise and lower the brush assembly. These cylinders are operated with separate controls. Sometimes, the two cylinders do not exert even pressure, causing one end of the broom to exert heavy pressure on the pavement while the other end barely contacts the surface. This is not a problem with newer models, since they are now manufactured with single controls. If an older model is being used on the job, care should be taken to watch for uneven pressure at opposite ends of the brush.

## Section 3

### Asphalt Distributor

#### General

The asphalt distributor is the most complex piece of equipment used in seal coat construction work because it has many components, and all must be operating properly. An asphalt distributor is a truck-mounted, insulated tank, with numerous special purpose attachments. A typical asphalt distributor is shown in Figure 7-3.



*Figure 7-3. Typical Asphalt Distributor.*

The major components are:

- ◆ Asphalt tank
- ◆ Heating system
- ◆ Circulating and pumping system
- ◆ Filter screens
- ◆ Spray bar
- ◆ Hand sprayer
- ◆ Controls and gauges.

The inspectors should record the serial number and model of the asphalt distributor and enter this information in the project folder.

## Asphalt Binder Tank

The asphalt distributor tanks vary in size. Those used for most seal coat work hold from 1000 to 2000 gallons of asphalt binder. Some tanks may be larger or smaller, but this range is adequate for most jobs. The tank is insulated to prevent the asphalt from cooling too quickly. Asphalt cement temperatures for seal coat work are commonly well over 300°F. If the tanks were not well insulated, the asphalt would cool quickly near the skin of the tank and could harden to unworkable levels.

The distributor must have a current calibration certificate in accordance with Test Method Tex-922-K, Part I. This means that the distributor has been checked to determine the accuracy of the measuring stick (strap stick) and the capacity of the tank. The calibration certificate is considered valid as long as it is current and there is no evidence or reason to suspect that any major modifications have been made to the distributor tank.

The tank unit should be visually inspected inside before it is filled. It should be clean to prevent contamination or mixing of different types of asphalt. Extreme caution should be used to avoid chemical or physical reactions that can occur when different asphalt binders are inadvertently used in the same tank.

The heater unit should be checked for proper starting and operation. Each burner should operate independently to allow either one to be used alone or simultaneously. The burner flames must be adjustable to regulate the amount of heat being directed into the flues. The fuel lines and burners should be free of fuel leaks.

**Baffle Plates and Flues.** The inside of the tank contains two or three baffle plates to stabilize the load while in motion. This is especially critical where a constant spray pressure is necessary. The tank has either one or two flues or heat ducts running lengthwise of the tank. These flues allow heat to be conducted into the center of the tank. In spite of the insulation in the tank, some heat loss is inevitable. By use of a burner system in combination with recirculation within the tank, the asphalt can be heated uniformly. Figure 7-4 shows the baffles and flues running through the asphalt tank.

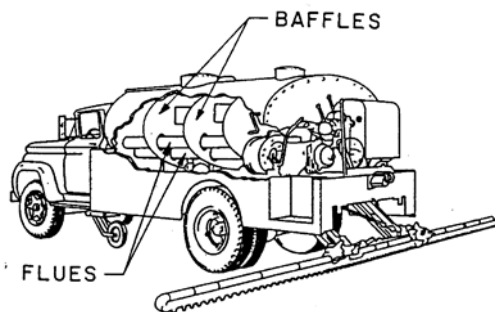

Figure 7-4. Illustration of Baffles and Flues Inside Distributor Tank.

**Thermometer.** The tank should be equipped with a thermometer. The thermometer should have a range from below 100°F to at least 400°F. Many models have a mercury thermometer mounted in a well in the side of the tank. It should have a chain to prevent it from being dropped and a screw-on cap to keep the well covered. Some models of distributors use a dial-type thermometer mounted outside the tank. These use a thermocouple that is mounted inside the tank. Both types of thermometers are acceptable and should be checked for accuracy. Infrared thermometers can be used to verify asphalt temperature. Another verification technique is to obtain a sample of the asphalt from the distributor and check with a separate thermometer. Figure 7-5 shows the tank thermometer being removed for taking a temperature reading.



Figure 7-5. Thermometer Removed from Distributor Tank.

**Manhole.** At the top of the tank is an opening commonly called a manhole. It has a heavy, hinged lid with a fastener. The manhole is used in filling the tank and permits visual inspection of the tank and its contents. The manhole is also opened to measure the amount of asphalt in the tank using a calibrated strap stick. The measuring process is called “strapping the tank” and will be described in detail in [“Seal Coat/Surface Treatment Application Process”](#). Figure 7-6 shows the manhole cover from the top of the tank.

**Vent.** All asphalt distributor tanks are equipped with a vent. The location of the vent will vary according to the manufacturer. Care should be taken to ensure that the distributor is always parked where there is adequate crosswind to prevent an accumulation of fumes (from the vent) to come in contact with the burner flame.

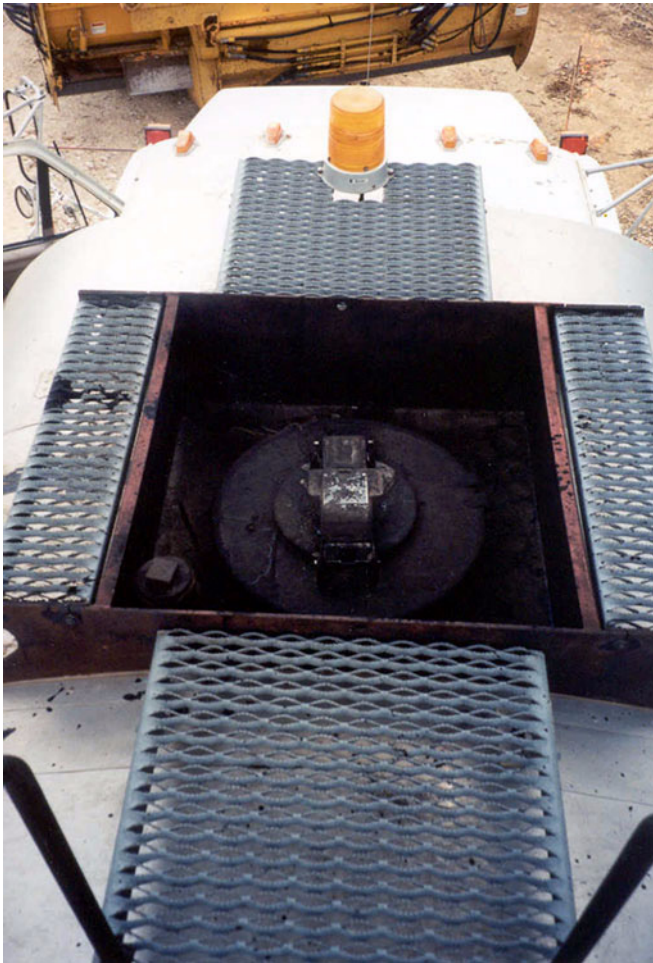

*Figure 7-6. Manhole Cover on Top of Distributor Tank.*

### **Distributor Heating System**

Asphalt temperature is a critical factor in the success of a seal coat/surface treatment. To maintain a constant temperature, a proper heating system is necessary.

**Burners.** Depending on the make and size of the distributor, either one or two propane or diesel fired burners are used. The burners are mounted on the platform at the rear of the tank and are positioned so the flame is directed into the flues that pass through the tank. Figure 7-7 shows a typical configuration.

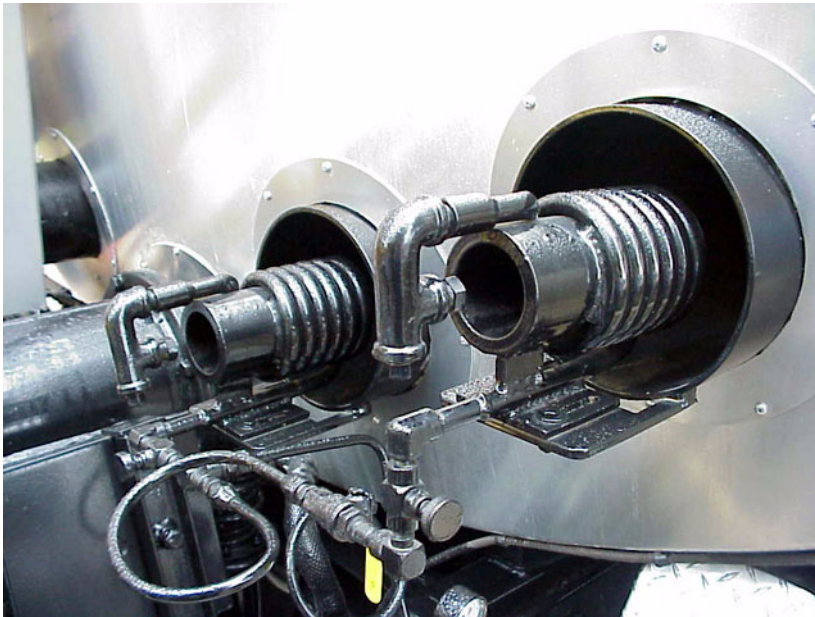

Figure 7-7. Burner Configuration at Rear of Tank.

**Heating.** The need for heating will depend on the following:

- ◆ Type of asphalt binder being used
- ◆ Ambient temperature
- ◆ Length of time the binder is in the distributor before being sprayed on roadway
- ◆ Whether the distributor is filled directly from heated storage tanks or has been hauled some distance in an insulated transporter.

Most emulsions used for seal coats are applied at 120°F to 160°F. When using asphalt cement, application temperatures may range from 275°F to 375°F. Application temperatures for cutback asphalts may range from 125°F to 275°F. Cutbacks should be shot 25°F to 50°F below their respective flash point. For each binder type, refer to Item 300, Asphalts, Oils, and Emulsions, for correct heating and application temperatures.

### Distributor Circulation and Pumping System

All asphalt distributors must have a power-driven pump to spray asphalt under pressure onto the roadway. The pumps also serve to provide a circulation system. There are two systems commonly used to supply pressure to the spray circulation system. One system has a separate engine mounted at the rear of the tank. This engine supplies power to the pump only. The other system uses power from the truck engine to operate the pump. This is called a hydrostatic distributor system as seen in Figure 7-8. A truck-mounted asphalt distributor is shown in Figure 7-9 and a trailer-mounted distributor is shown in Figure 7-10.



Figure 7-8. Hydrostatic Distributor Located at Front of Truck.



Figure 7-9. Truck-Mounted Asphalt Distributor.





Figure 7-10. Trailer-Mounted Asphalt Distributor.

**Function.** In addition to providing the power to spray asphalt binder on the road, the pump provides power to perform the following functions:

- ◆ Circulate the asphalt throughout the tank. This is necessary to prevent asphalt from burning if it remained next to the flues for an extended period. Also, it will prevent asphalt from remaining near the skin of the tank long enough to cool and harden.
- ◆ Circulate asphalt through the spray bar and bring unused asphalt back into the tank. This will prevent asphalt from remaining in the spray bar long enough to cool, harden, and clog the spray nozzles.
- ◆ Pump unused asphalt out of the distributor.
- ◆ Pump from one storage tank to another. It may be used as an auxiliary pump to transfer asphalt from one tank to another.
- ◆ Fill the distributor tank. If a storage tank, heater unit, or transporter unit is not equipped with a pump, the distributor spray pump may be used to fill the distributor tank.

### Filter Screens

Most distributors have filter screens in the main piping between the tank and the spray bar. The purpose of these wire-mesh filters is to prevent particles of burned asphalt or impurities from entering the spray bar and clogging the spray nozzles.

These screens should be removed and washed with diesel fuel, or particles should be burned off with a torch. This will prevent a blockage of the flow of asphalt, allowing it to flow under full pressure to the nozzles. On a large project, the filters should be cleaned periodically.

### Distributor Spray Bar

The spray bar and spray nozzles regulate the amount of asphalt sprayed on the roadway and regulate the spray pattern. Figure 7-11 shows a typical distributor spray bar.



*Figure 7-11. Typical Distributor Spray Bar.*

The spray bar on most distributors used on seal coat projects is 12 feet wide – the width of a typical traffic lane. Different bar widths are available. Ten to 14-foot widths are recommended.

The bar is composed of a series of spray nozzles evenly spaced (every 4 inches) along the bar. It contains a return line for continuous circulation of asphalt through the bar. Some models are equipped with shut-off valves on each nozzle to allow closing a few spray nozzles for spraying irregular areas. Figure 7-12 shows the nozzles on a typical spray bar.

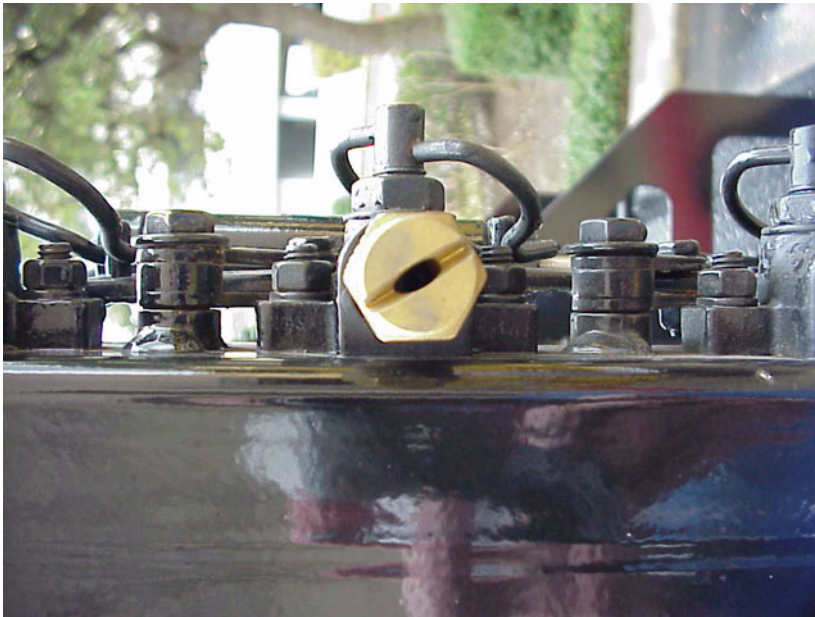

*Figure 7-12. Nozzle on Typical Spray Bar.*

**Hinged Bar.** Most spray bars are hinged at each end to allow the end to be folded up when spraying is not in progress. The distributor should never be driven in traffic with the ends extended, because they extend beyond the sides of the truck. Some have chains attached at the ends of the bar and to the truck chassis. The chains help to support the ends of the bar when they are in the spray position. Chains may also serve as a safety hitch to hold the ends securely in the upright position. Figure 7-13 shows the spray bar ends folded up.



*Figure 7-13. Hinged Spray Bar with Ends Folded Up.*

**Spray Nozzles.** Nozzles are manufactured with different size openings to permit different application rates of asphalt. Nozzles are designed to spray a fan-shaped pattern, rather than a circular spray. Viewed from the top they would look as shown in Figure 7-14. Viewed from behind the distributor, they would appear as shown in Figure 7-15. Some distributors are equipped with a second spray bar, sometimes called a wheelpath bar. This second spray bar is used to spray a different application rate in the wheelpath and is controlled with a separate computer.

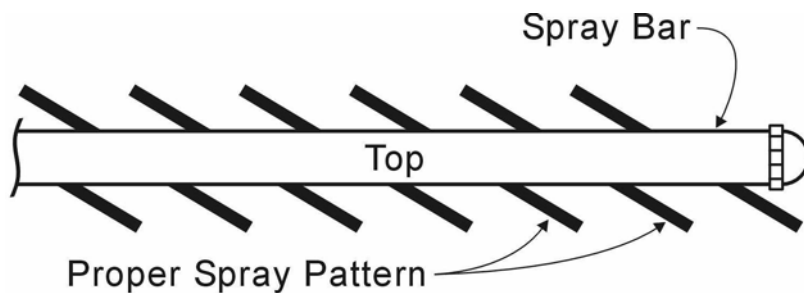

Figure 7-14. View of Distributor Bar as Seen from Top of Distributor.

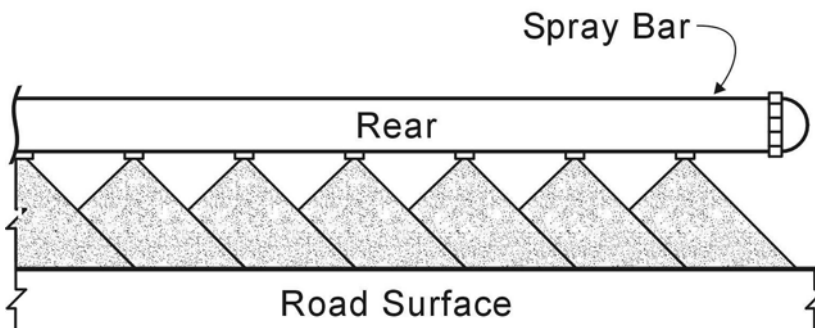

Figure 7-15. View of Distributor Bar as Seen from Rear of Distributor.

**Inspecting the Spray Bar.** To inspect the spray bar, it should be raised and, if possible, rotated outward so the nozzles can be inspected as shown in Figure 7-16. The nozzles are critical to obtain uniform asphalt coverage. They must be in good condition and properly oriented to obtain consistent asphalt coverage across the width of the lane being sealed. Nozzles are typically made of brass and can easily be gouged or otherwise damaged, which will affect spray pattern.



Figure 7-16. Distributor Spray Bar Rotated Outward.

The following is a list of several items on the spray bar that must be inspected.

- ◆ **Spray Bar Ends.** The ends of the bar should be checked to see that they can be raised and lowered. There should be some method of securing the ends in the raised position. Most models are equipped with a chain device to secure the ends when raised.
- ◆ **Bar Position.** The bar should be straight when the ends are lowered. This should be checked in all directions. Spray patterns will be distorted if the bar is not straight.
- ◆ **Hoses, Joints and Pipes.** There should be no leaks in any of the hoses, joints, and pipes. If asphalt leaks onto the pavement when the distributor is not spraying, a puddle of asphalt will form. This type of spill is difficult to clean up and will usually result in too much asphalt at that location which will bleed through the cover aggregate.
- ◆ **Spray Bar Width.** The spray bar must be checked to ensure it is the correct width. Ensure that the proper amount of extensions and nozzles have been installed to cover the required width.
- ◆ **Spray Bar Height.** The height of the spray bar should be checked. The distributor must be parked on a flat, level surface, with the bar in the lowered position. The height should be measured from the bottom of the nozzles to the pavement surface. Measurements should be taken at various points across the width of the spray bar to ensure that the height is constant. Set the height according to the manufacturer's recommendations. The bar height should be measured first with the tank empty and checked again after the tank is full. If there is more than about 1 inch difference corrective action should be taken. This will prevent a change in the overlap of the fan pattern between the beginning and end of a shot.
- ◆ **Spray Nozzles.** A nozzle is mounted every 4 inches along the width of the spray bar. The correct number of nozzles should be in place for the width being sealed. If a variable spray rate is to be used, the nozzles should be checked to see that they are the proper size and in the correct

location. If there are more nozzles than needed, the operator should close off the extra nozzles. To achieve a straight, sharp edge of asphalt coverage, use a deflector nozzle at the ends of the spray bar. Do not allow the end nozzle to be turned perpendicular to the spray bar axis in an attempt to get a sharp edge, because it will cause too much asphalt at the edge and it robs the next nozzle of the overlap normally provided by the end nozzle.

**Nozzle Angle.** The nozzles must be set to the proper angle according to manufacturer's specifications. The angle is usually between  $15^{\circ}$  to  $30^{\circ}$  as shown in Figure 7-17, depending on the manufacturer. All nozzles must be set at the same angle to avoid distortion of the spray pattern. Every distributor should be equipped with a tool used to accurately set the proper angle.

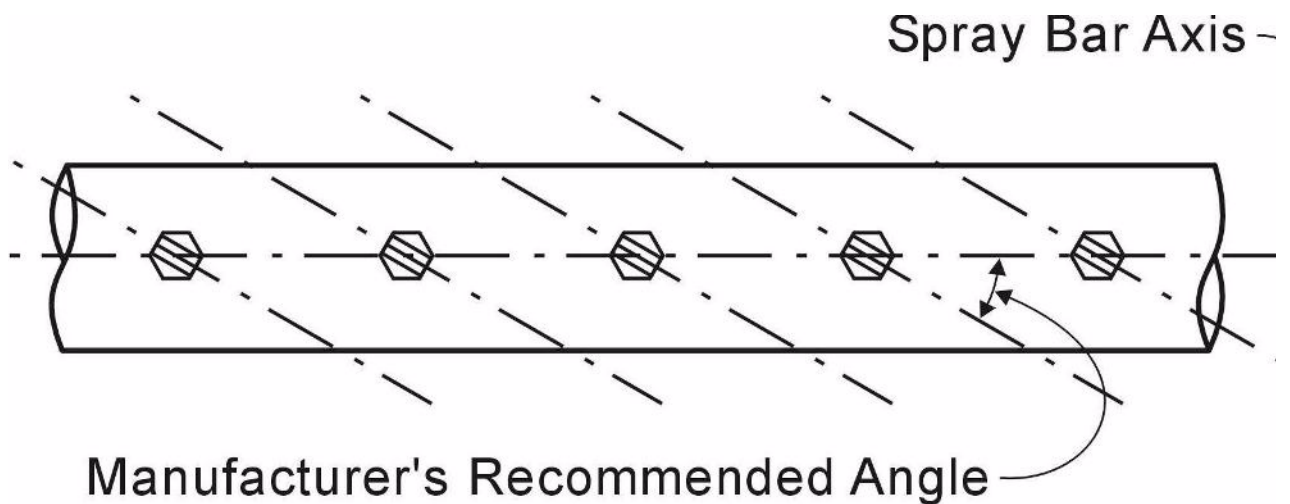

Figure 7-17. Nozzles on Spray Bar Set at Manufacturer's Recommended Angle.

The proper spray pattern depends directly on the exactness of the nozzle angles. If not set correctly, the fan pattern can be distorted as shown in Figure 7-18.

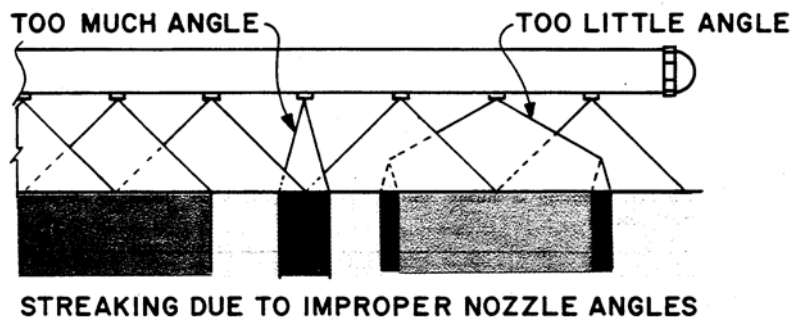

Figure 7-18. Effect of Incorrect Nozzle Angle.

**Fan Width.** In addition to the nozzle angle, the height of the spray bar is critical to obtaining a correct spray pattern. The height of the bar above the surface of the roadway determines how wide the fan spreads. Triple lap coverage as shown in Figure 7-19 is desirable and is achieved at a spray bar height of 12 inches.

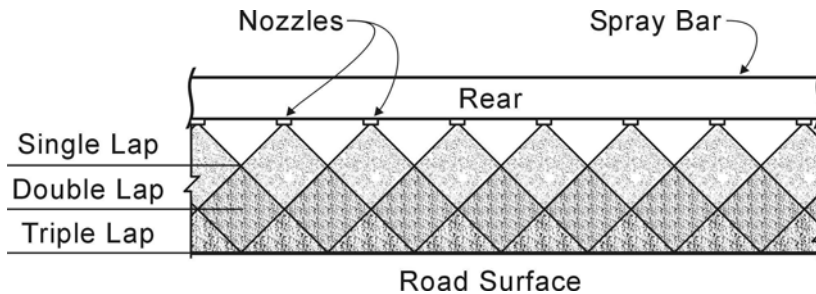

Figure 7-19. Various Asphalt Spray Patterns.

Standard truck springs will compress under a heavy load, and flex back to an arch when the load is removed. If an asphalt distributor had standard springs, the spray bar would be one height when the tank is full. As the asphalt is sprayed and the tank empties, the spray bar would rise with the decreased weight on the springs. Consequently, the beginning of the shot would have triple lap coverage, but the lap would increase as the spray bar height increases. This would cause streaking.

To avoid this inconsistency, most distributors are equipped to either prevent the springs from compressing under a load or to prevent them from arching back with a near-empty tank. Many are stabilized with compressed air. The important point is that the spray bar should remain at a constant height whether the tank is full or empty.

To check the fan width, the operator should back onto a flat area and place one or two layers of brown paper under the spray bar. Have the operator turn the spray on momentarily. Make certain he turns it off as quickly as possible. This will not give an exact representation of the fan widths, but it will quickly reveal any problems with the spray pattern. If this is not conclusive, the operator may spray a short test strip (20 to 30 feet). This will usually reveal any nozzle problems.

**Nozzle Output.** The amount of asphalt being sprayed out of each nozzle will vary. Nozzle output should be tested in accordance with TxDOT Test Method Tex 922-K, Part III (bucket test) to ensure each nozzle is spraying within the correct tolerance.

Buckets for the bucket test must be shaped so they will fit under the nozzles side-by-side. A 4-inch diameter by 8-inch height concrete cylinder mold as shown in Figure 7-20 is commonly used for the bucket test.

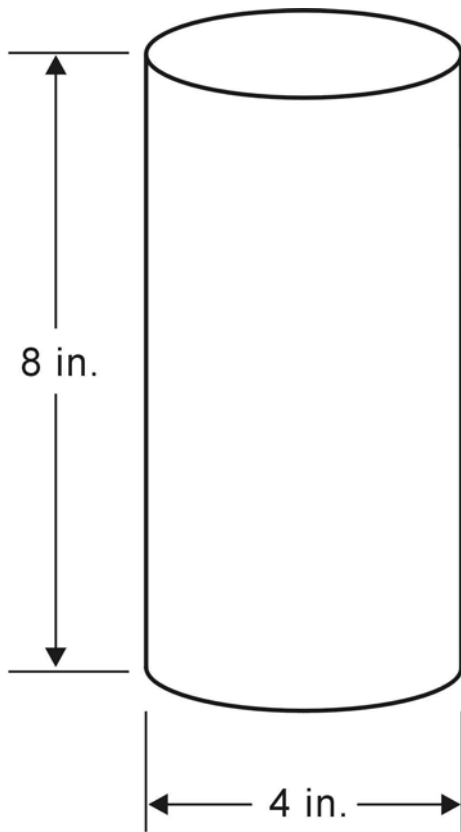

## **Concrete Cylinder Mold**

*Figure 7-20. Concrete Cylinder Mold Typically Used for Spray Bar Calibration.*

If asphalt is used for the test, it should be heated to the temperature at which it will be applied. Water may also be used for this test. Before the test begins, the spray bar should be turned on for a short period of time to make certain none of the nozzles are clogged. The distributor should be moved off the test area to blow out the nozzles.

If all nozzles are working, the test can proceed. If any nozzles are clogged, they should be removed and cleaned or taken out of service.

A container should be placed under each nozzle to catch all the flow from that nozzle as shown in Figure 7-21. Set the pump pressure or speed to match the application rate for the seal coat work. When the containers are all in position, turn the sprayer on briefly to fill the containers to about 3/4 full.





Figure 7-21. Calibration of Asphalt Distributor Spray Bar.

Item 316, **Surface Treatments**, requires that there be no more than a 10 percent variation in the weight of the contents between each bucket. If water is used for this test, all water must be removed from the distributor tank after calibrating the spray bar. Adding hot asphalt will cause water in the tank to be converted to steam resulting in an explosion, which may result in serious injury. At the least the asphalt tank is likely to overflow via the manhole, possibly endangering those nearby.

**Transverse Variation.** Some seal coat work may require the application of more asphalt binder outside the wheel paths to prevent aggregate shelling. The rate variation can be achieved by using different nozzle sizes outside the wheel path versus in the wheel path.

## Hand Sprayer

All distributors should be equipped with a hand sprayer for use in narrow, irregular-shaped areas that are inaccessible to the spray bar. Figure 7-22 shows a typical hand sprayer. The handle shown on the right side of Figure 7-23 also serves as the shut-off valve control. To turn the spray on, the operator turns the handle 90°.



Figure 7-22. Typical Hand Sprayer on Asphalt Distributor.



Figure 7-23. Handle-Control Valve.

### Distributor Controls and Gauges

The asphalt distributor must deliver a uniform and precise amount of asphalt onto the roadway. Equally as important is the need for consistency throughout the length of the asphalt shot. Many gauges and controls are necessary to achieve this consistency.

**Thermometer.** As mentioned earlier, a thermometer is used for monitoring asphalt temperature. Most are located in a well in the side of the tank. Some models have a dial thermometer mounted on the outside of the tank, with a thermocouple inside the tank. This type is more convenient to use

and easier to read than the mercury thermometer, which must be removed from the well, but it is subject to malfunctions.

**Volume Gauge.** Most tanks are equipped with a volume gauge as shown in Figure 7-24. These should be used only as a convenience to the operator to know when the tank is getting close to empty. They should never be used as the basis for payment.



Figure 7-24. Volume Gauge on Distributor Tank.

**Strap Stick.** The manufacturer supplies a measuring stick (strap stick) with the distributor. Some distributors have the gallon levels on the stick itself. Others have a metal scale riveted on the side of the frame as seen in Figure 7-25. The stick or scale must be in accordance with Test Method Tex-922-K, Part I. A discussion of how the distributor is “strapped” is provided in Chapter 8.



*Figure 7-25. Strap Stick Used to Measure Quantity of Asphalt in Distributor Tank.*

**Pump Pressure or Rate.** All asphalt distributors have a power-driven pump to spray asphalt under pressure onto the roadway. The pumps also serve to provide a circulation system. Some distributors measure the pump pressure in pounds per square inch (psi) in the lines. This type of distributor is equipped with a conversion chart supplied by the manufacturer. The chart converts the amount of psi into gallons per minute (gpm) dispensed at the spray bar. Another type of distributor has the pump rate measured in gallons per minute increments. The gauge is a very important device, because the pressure under which asphalt is being sprayed will greatly influence the quality of the job. If the pressure is too low, the asphalt will streak and the pattern will be uneven. If the pressure is too high, the asphalt may atomize and the pattern may be distorted. The ill effects of this are magnified by high wind.

The pump should be operated at the highest pressure possible without atomizing the asphalt. The way to determine the ideal pressure or pump rate is through field tests. Once the ideal pressure is determined from the test, the pump should be operated at that rate or pressure.

Most distributors are computerized so that the desired binder application rate is set by the distributor operator who then must operate the vehicle at a specific engine RPM.

**Digital-Measuring Instrument (DMI).** Specifications require that a vehicle be furnished with a calibrated digital-measuring instrument, accurate to plus or minus 6 feet per mile. The inspector should verify that no modifications have been made that might affect the accuracy of the measuring instrument since calibration.

**Valve Control.** Another important control is the valve control which turns the spray on and off. A distributor operator must be able to turn all spray nozzles on and off simultaneously and instantaneously. This is a simple task in a computerized distributor and can be accomplished from inside the cab with a switch on the control panel as shown Figure 7-26.

At the beginning and end of a shot, the distributor passes over paper, which masks the pavement to form a straight, sharp line. The distributor must pass over the masking paper on both ends at spraying speed. The operator must be able to turn all nozzles on in the split second that the distributor passes over the masking paper.



Figure 7-26. Computerized Asphalt Distributor Controls.

A **computerized** distributor may be operated by one person, but a **manually** operated distributor requires two people. On manually operated distributors, the driver lines up the machine and keeps it on line at the correct speed, while the spray operator works the valve control, and, on some models, sets the pump motor speed and monitors pump pressure. These two people must work as a team.

## Section 4

### Aggregate Spreader

#### General

The aggregate spreader, sometimes called the “spreader box” is used to distribute aggregate evenly over the film of asphalt sprayed by the asphalt distributor. The specifications require aggregate spreaders to be self-propelled and have a continuous feed feature. The type most commonly seen on a seal coat project is shown in Figure 7-27.



Figure 7-27. Aggregate Spreader or Spreader Box.

The spreader receives aggregate from a haul truck that dumps the aggregate into a receiving hopper at the rear of the spreader. A conveyor system transports the aggregate to another bin at the front of the vehicle. Gravity spreads the aggregate evenly across adjustable gates, which allow precise amounts of aggregate to pass through.

The major components of the aggregate spreader are as follows:

- ◆ Truck hitch
- ◆ Receiving hopper
- ◆ Belt conveyors
- ◆ Spreading hopper
- ◆ Discharge gates
- ◆ Discharge roller.

The spreader must distribute cover aggregate at a uniform rate over the entire width and length of the area being sealed. Not only must it be uniformly spread, it must also be the correct quantity of

aggregate. For a clear understanding of how this is done, each component of the spreader will be described further in this section.

Part of the visual inspection of the aggregate spreader should be directed at the overall condition of the power train, primarily detecting evidence of leaks in the engine and transmissions.

The manufacturer's name, spreader model number, and serial number should be recorded.

### Truck Hitch

To be operated properly, the haul truck should back up to the spreader; a coupling on the spreader should engage on the rear of the truck; the coupling should lock securely together; and the spreader box should pull the truck (in neutral gear position) behind it. The truck should not push the spreader box. This is very important, because the amount of aggregate covering the asphalt depends partially on the traveling speed of the spreader. Thus, to maintain a constant speed and ensure a uniform aggregate application rate, the spreader must regulate its own speed.

The spreader coupling must be able to lock securely with the truck hitch, and the spreader box operator must be able to release the hitch easily and quickly. Figure 7-28 is a photo of a typical spreader box truck hitch arrangement.

The truck hitch should be visually checked for anything broken or bent. Ensure the locking mechanism is working properly by having a truck hook up to the spreader box. Have the operator manipulate the release to be sure it will disengage the truck effectively.



Figure 7-28. Aggregate Spreader Truck Hitch.

### Receiving Hopper

After the truck has engaged the hitch on the spreader, the truck bed is raised and aggregate is dumped into the receiving hopper. The receiving hopper is seen in Figure 7-29. Its only function is

to receive the aggregate from the truck. At the bottom of the receiving hopper, there are openings through which the belt conveyors must pass in a continuous loop. A rubber shield prevents aggregate from piling up on the belt, being carried ahead of the receiving hopper and being spilled onto the ground. This shield should not be torn or missing so that it can function properly.



*Figure 7-29. Receiving Hopper of Aggregate Spreader.*

The receiving hopper should be visually checked for overall condition. There should be no holes or large gaps that would allow aggregate to fall through to the road surface. The conveyor belt system should have rubber, neoprene, or fabric cowling (or flaps) around it to prevent aggregate loss.

There should also be a flap on top of the receiving hopper to ensure a tight fit against haul trucks as the aggregate is being dumped into the receiving hopper.

### **Belt Conveyors**

There are two belt conveyors, which transport the aggregate. These can be seen on each side of the photo in Figure 7-30. These belts must be in good condition and not frayed enough to allow aggregate to spill over the sides onto the roadway.

The operator should start the conveyors and demonstrate the speed control. The speed should be variable to ensure that the supply of aggregate reaching the front hopper can be increased or decreased as needed.

There should not be an excessive amount of slack in the belts since this will cause sagging and loss of aggregate off the sides. If there is too much slack, the belts must be tightened.





Figure 7-30. Belt Conveyors on Aggregate Spreader.

### Discharge Hopper

The discharge hopper receives the aggregate from the belt conveyors and distributes it laterally in the hopper. The aggregate falls over two angular devices at the top of the discharge hopper, as seen in Figure 7-31. Also in this photo is a scalping device. This can consist of either a series of bars or a coarse mesh to separate any large rocks, dirt clods, or weeds from the aggregate.

The hopper should be checked to ensure that it is clean and does not contain any aggregate particles from a previous project. The scalping grate should be checked to ensure that it covers the entire top of the hopper. This grate performs the very important function of keeping large clay balls and other foreign matter out of the fresh asphalt binder. Also, there should be no holes or cracks in the hopper, where aggregate can fall through and cause a ridge or row of excess aggregate.

The exterior of the discharge hopper should be checked for damage. Occasionally, a spreader will be driven over a large rock or other object damaging the lower front corners. Damage of this sort may be critical, because the roller bearings are held in a casing in this section of the hopper. Damage can cause the roller to wobble resulting in an uneven flow of aggregate.



Figure 7-31. Discharge Hopper of Aggregate Spreader.

### Discharge Gates

On the bottom of the discharge hopper are a series of discharge gates as shown in Figure 7-32 that can be opened by operator control to discharge the aggregate. Each gate can also be opened or closed individually by a switch located at the top and in the front of the discharge hopper.

Check to see that they are correctly adjusted to close the gates fully. You will not be able to judge whether the adjustment is correct when the gates are open, until the spreader is actually dispensing aggregate.



Figure 7-32. Discharge Gates on Aggregate Spreader.

## Discharge Roller

Some aggregate spreaders have a roller at the bottom of the discharge gates which spins to assure an even flow of aggregate onto the asphalt. This roller (Figure 7-33) ensures that an even amount of aggregate is spread laterally across the pavement. The roller must be straight, not warped, for the aggregate to be distributed evenly.

The discharge roller should be visually examined to ensure there is no mud or other debris caked on its surface. A string line should be stretched from end to end of the roller to be certain it is not warped. To check the end bearings of the roller for excessive wear, the spreader should then be turned on and observed for wobble in the roller or noise coming from the bearings as they turn.



*Figure 7-33. Discharge Roller on Aggregate Spreader.*

## Wheels and Tires

With the spreader in motion, the wheels should be observed for any indication of wheel wobble or excessive toe-in or toe-out. Any of these conditions will tend to cause the tires to scuff the aggregate. The spreader box is the first vehicle to drive over the freshly placed aggregate, and when the spreader's tires pass over the aggregate, the aggregate particles will still be in unarranged positions. Any scuffing by the spreader's tires may shove the aggregate sideways rather than straight downward. Scuffing will appear as a dark, ragged-looking strip causing asphalt to be picked up on the tires of the pneumatic rollers.

The tires should be checked to detect any gouges that might adversely affect the aggregate arrangement. Gouges that may weaken the sidewall could lead to a tire blowout. This type of faulty tire should be changed before the project starts.

---

## Brakes and Clutch

The operator should stop and start the spreader a few times so the operation of the clutch and brakes can be checked.

## Tailgate Aggregate Spreader

The tailgate of a haul truck is sometimes used as an aggregate spreader by state maintenance forces in spot sealing. Some TxDOT districts have installed air-operated tailgate spreaders. Figures 7-34 through 7-37 show how modifications can be made to the typical truck so that an employee is no longer needed to ride on the tailgate spreader. This will reduce the number of employees needed in the crew and improve safety in the operation.

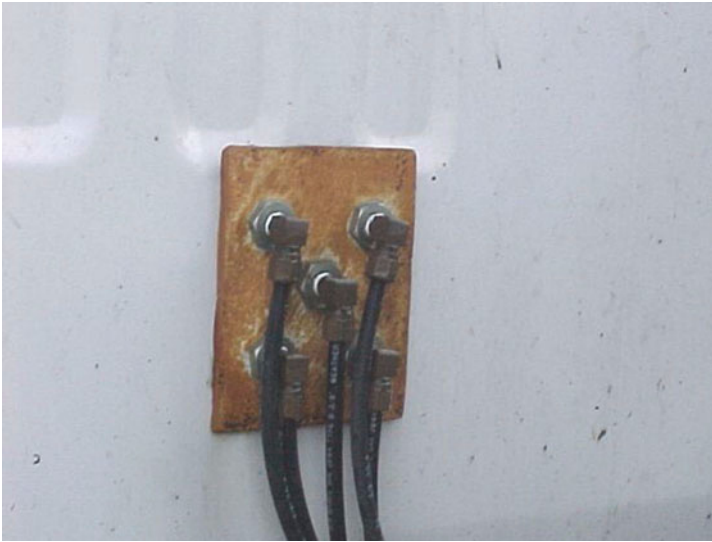

*Figure 7-34. Air Line Connections on Back of Truck Cab*



Figure 7-35. Control Valve in Truck Cab.



Figure 7-36. Mirror to View Rock in Truck and Rock Flow



*Figure 7-37. Air Cylinder to Open/Close Spreader*

## Section 5

### Haul Trucks

#### General

The cover aggregate is stockpiled before the start of the seal coat project. The stockpiles are placed alongside the roadway in the immediate vicinity of the project so that the aggregate does not have to be hauled a long distance when seal coat work begins.

The trucks used to transport the aggregate and dump it into the spreader box are usually of the end-dump variety. They are normally either tandem-axle or single axle trucks like the one shown in Figure 7-38.



Figure 7-38. End-Dump, Single-Axle Aggregate Haul Truck.

#### Size

The size of the truck bed is an important factor and is expressed in cubic yards. The single-axle trucks normally carry 6 cubic yards of aggregate.

The bed capacity for tandem-axle trucks is usually 12 or 14 cubic yards. The capacity may be increased by adding boards at the top of the sides.

#### Condition

All trucks used on a seal coat project should be in reasonably good mechanical condition. They should be free from leaking fuel, crankcase or transmission oil, engine coolant, and hydraulic fluid. Any of these fluids leaking onto a fresh seal coat usually prevent proper bonding of the asphalt and

aggregate. All trucks must be legally registered to operate on the public highway and have appropriate safety equipment.

### Hoist

All trucks must have a hoist mechanism to enable the bed to be raised in order to dump the load into the receiving hopper of the spreader unit. The truck operator should raise and lower the bed, so the operation of the hoist can be checked. The hoist mechanism should operate properly and be free of hydraulic leaks.

### Tailgate

The tailgate should be hinged at the top and have the capability of being latched closed at the bottom as shown in Figure 7-39. This prevents the aggregate from spilling out until the tailgate is unlatched. As the bed is raised, the locking mechanism on the tailgate should be checked. It should lock securely when the bed is in the down position and unlock smoothly as the bed begins to rise.

### Hitch

Every truck should be equipped with a hitch that is compatible with the one on the spreader box. This is very important, since the spreader box tows the truck as the load is being emptied. In most cases, this is a bar-type hitch as shown in Figure 7-40.



Figure 7-39. Latch on Tailgate of Haul Truck.





Figure 7-40. Truck Hitch to Connect to Aggregate Spreader.

### Identifying Numbers

TxDOT requires that each truck used on a seal coat contract have a unique identifying number attached similar to that shown in Figure 7-41. The number must be securely attached and clearly legible throughout the project.



Figure 7-41. Haul Truck with Identification Number Affixed.

This number is important for enabling the inspector to identify each truck on the project at a glance. Every truck must be inspected before the project begins, and the bed of each truck must be measured. It would be possible to substitute an unauthorized truck on the job if numbers were not plainly and immediately identifiable. The identification number, the truck bed measurements, and cubic yard capacity should be recorded.

## Bed Measurements

The volume of each truck bed must be obtained because aggregate is typically paid by the number of cubic yards placed on the roadway. Each truck is measured, and the number of full loads placed on the roadway is counted to arrive at the pay quantity of aggregate.

Ideally, all trucks used on the project should have the same capacity to easily compute the volume of aggregate placed on the roadway. There is no particular truck size that is best.

The length (L), width (W), and height (H) of the inside of the truck bed should be measured to the nearest 0.05 feet as shown in the example below. These three measurements are multiplied to obtain the volume in cubic feet. This product is then converted to cubic yards by dividing by 27 as shown in the following example.

EXAMPLE: Volume of Truck Bed (V):

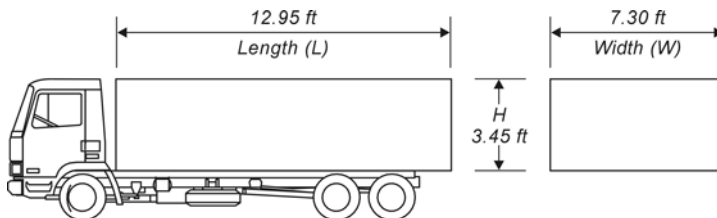

Figure 7-42. Volume of Truck Bed

$$V = \frac{L \times W \times H}{27}$$

$$V = \frac{12.95 \times 7.30 \times 3.45}{27}$$

$$V = 12.08$$

Equation 7-1.

Note: round 12.08 CY to 12 CY.

## Volume of Truck Bed with Deduction for Hydraulic Ram Cover

Some trucks have the hydraulic ram recessed into the truck bed, with a housing in the bottom front portion of the bed. If the trucks on the project have this, the volume of the housing must be deducted from the total volume of the truck bed as shown in the example below.

EXAMPLE: Volume of Hydraulic Ram Cover

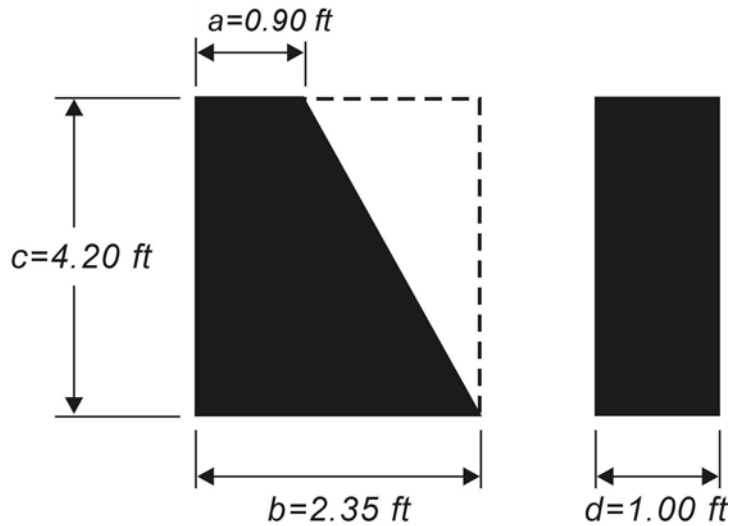

### Hydraulic Ram Cover

Figure 7-43. Hydraulic Ram Cover

$$V = \left[ \left[ \frac{(a+b)}{2} \right] \times c \times d \right] \div 27$$

$$V = \left[ \left[ \frac{(0.90 + 2.35)}{2} \right] \times 4.20 \times 1.00 \right] \div 27$$

$$V = 0.25 \text{ CY}$$

Equation 7-2.

Net Volume of Truck Bed

$$NV = 12.08 \text{ (previous example)} - 0.25$$

$$NV = 11.83 \text{ CY, round to 12 CY}$$

### Acceptable Size

In the above example, the capacity of the truck bed, 11.83 CY, is less than an even number of cubic yards, which is not acceptable. It should be an even number of cubic yards or slightly over. To ensure an accurate count of the cubic yards of aggregate for which the contractor is paid, the bed capacity must be expanded. The easiest method to accomplish this is to add sideboards.

By adding a standard **2x4** on top of the metal truck bed sides, the capacity can be increased to slightly over 12 CY, which would be acceptable as a 12 cubic yard truck. The addition of boards (**2x4s** or **2x6s**) is common practice. This is acceptable if the trucks do not exceed the gross vehicle weight established by law.

## Section 6

### Rollers

#### General

After aggregate is placed on the asphalt, rollers orient the aggregate in its flattest dimension and seat it firmly into the asphalt binder.

A pneumatic roller is recommended for all seal coat and surface treatment work. A steel-wheeled roller is not recommended because the flat, steel drum will tend to crush the aggregate, especially on the high spots. This is particularly true when lightweight aggregate is used. In addition, if the old pavement is rutted, a steel-wheeled roller will tend to bridge over the ruts failing to seat the aggregate firmly in the low spots of the wheel paths.

#### Identifying Data

The manufacturer's name (or brand name), model number, and serial number of all rollers used on the project should be recorded.

#### Weight Certification

Manufacturers publish the gross weights of their product with water and wet sand as ballast. If either of these materials is used and the ballast tanks are full, the inspector can safely certify whether or not it meets the weight requirements.

If, however, the contractor uses another material, such as aggregate for ballast, it may be difficult to determine if the rollers meet the weight requirements. When in doubt, the contractor should be required to have the rollers weighed. A weight ticket should be obtained with a certified vehicle weight and included in the project folder.

#### Pneumatic Rollers

Pneumatic rollers operate on rubber, air-inflated (pneumatic) tires. Figure 7-39 shows a pneumatic roller typical of those used for seal coat and surface treatment work. All pneumatic rollers must be self-propelled and capable of operating in both forward and reverse.



Figure 7-44. Pneumatic Roller.

**Weight.** Many project plans will call for light pneumatic rollers which are described in Standard Specifications Item 210, [Rolling](#). This item requires that a light pneumatic roller be capable of ballast loading, to uniformly vary the total vehicle weight from 9000 pounds to 18,000 pounds. Wet sand or aggregate may be used for ballast.

**Contact Pressure.** Contact pressure exerted by each tire is a function of the following combination of factors:

- ◆ Total vehicle weight
- ◆ Number of tires on the roller
- ◆ Tire size and ply rating
- ◆ Tire inflation pressure.

Item 210 requires a minimum contact pressure of 45 pounds per square inch (psi) of tire contact area, as a minimum for the light pneumatic-tire roller. All tires must be smooth surfaced as shown in Figure 7-40.



Figure 7-45. Smooth-Surfaced Pneumatic Tire.

**Tire Inflation.** The roller shall provide a uniform compression under all wheels. Specifications require that all tires be inflated so that there is not more than 5 psi variation within all tires. Correct tire pressure is very important. If one tire is soft, it will not seat the aggregate as firmly as the other tires, and this could result in the aggregate in that path stripping away under traffic.

[Appendix C](#) of this Manual contains a tire inflation chart. This chart provides tire pressures for all commonly used tire sizes and ply ratings.

**Number of Tires.** Specifications require that light pneumatic rollers have a minimum of nine tires. Most are manufactured with five wheels on the front and four on the rear. The rear wheels are the drive wheels; the front wheels are the steering mechanism.

**Area of Coverage.** Light rollers are required to cover an area approximately 60 inches wide on each pass. The rear tires must be offset to provide coverage of the areas between the front wheels as shown in Figure 7-41.

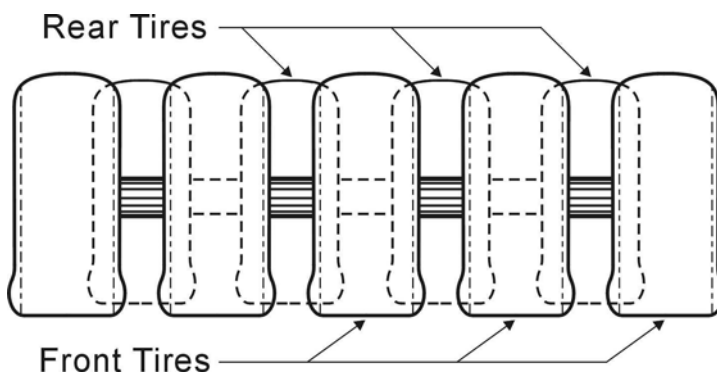

Figure 7-46. Wheel Configuration on Pneumatic Rollers.

**Wheel Wobble.** The wheels must not wobble when the roller is in operation. This can cause aggregate to be displaced. If any wheel is not operating smoothly, the roller should not be allowed to continue operation.

**Free of Leaks.** Like all other pieces of equipment on any construction project, rollers must not leak engine coolant, fuel, hydraulic fluid, or anything else that might contaminate the asphalt binder or aggregate. If any leaks are detected, the roller must immediately be removed from the project.

**Smooth Operation.** All rollers must be capable of smooth operation, especially when turning, stopping, or starting. If the brakes or drive train are faulty and cause jerking or excessive vibration when the roller is stopped or started, it should not be allowed to continue operation. If one of the wheels is out of alignment, it may cause “scuffing.” None of these conditions should be permitted on the job.

**Medium-Weight Rollers.** Medium pneumatic rollers may be used on some projects. The information given for light pneumatics is also true for medium-weight rollers, with the exception of the weight, number of wheels, contact pressure, and width. Medium rollers must be capable of varying the weight, by adding ballast, from 23,500 pounds to 50,000 pounds. There must be no less than seven wheels, with contact pressure of 80 pounds per square inch (psi) or more. The effective rolling width should be approximately 84 inches.

**Tire Pressure.** Tire pressure is probably the most critical inspection point for pneumatic rollers. The variation in the pressure cannot exceed 5 psi within the group of tires.

The correct tire pressure is a function of these variables:

- ◆ Gross vehicle weight
- ◆ Number of tires on the roller (Either seven or nine are required for this class of roller. Most used on seal coats have nine.)
- ◆ Tire size and ply rating
- ◆ Required ground contact pressure, as specified in Item 213.2. For light pneumatic rollers, contact pressure of 45 psi is required. For medium (Type A), 80 psi is required; for medium (Type B), 90 psi. These are the minimum amounts; higher contact pressures are allowed.

Assume that you are inspecting a light pneumatic roller. You have a certified weight ticket showing the gross weight of the roller as 17,700 pounds. It is a nine-wheeled roller. The tires are 7.50 x 15, 6 ply. Standard Specifications call for a minimum of 45 psi contact pressure per wheel.

First divide the number of wheels into the gross vehicle weight, to determine the weight on each tire (wheel load).



$$\frac{17,700 \text{ lbs.}}{9 \text{ tires}} = 1967 \text{ lbs wheel load}$$

Equation 7-3.

Next, turn to the Pneumatic Tire Pressure Table in [Appendix C](#). Look in the left-hand column which gives tire size and ply. Find the block that applies to 7.50 x 15, 6 ply tires. The next column gives wheel load. Since the blocks are broken down into 250 pound increments, the chart shows 1750, then 2000 pound wheel loads. Since the 1750 block is less than the 1967 pound wheel load on our roller, go to the 2000 pound block.

The next column to the right is Inflation Pressure. Skip over this column and go to the one titled Contact Pressure. The Specifications call for a minimum of 45 psi Contact Pressure. Again, there is a division of only 43 and 46 psi, so you must use the higher number. Reading back to the left one column (Inflation Pressure), you find that 40 psi is the minimum inflation pressure for the tire sizes used on our example.

### Inspection Checklist

All of the rollers to be used on the project should be given a thorough overall visual inspection. This visual check should include the following:

- ◆ Check overall condition of the equipment.
- ◆ Check for presence of leaks of any kind.
- ◆ Tires should be smooth (no tread pattern).
- ◆ All tires should be the same size and ply rating.
- ◆ The rollers should start and stop smoothly. Brakes should not “grab.”
- ◆ The roller must be self-propelled and operate in both forward and reverse.
- ◆ There should be no wheel wobble, since this will scuff the cover aggregate.
- ◆ Check tire stability on turns. If there is unusual scuffing, it may mean a bad bearing or king pin, which might not be detectable when the roller is moving in a straight line.
- ◆ Roller tires should have no gouges that would alter the contact pressure of the tire.
- ◆ Certify the weight.

---

## Section 7

### Front-End Loader

#### General

Front-end loaders are used to move aggregate from the stockpile into the haul truck. Figure 7-42 shows a typical front-end loader. Loaders, like all equipment, must be in good mechanical condition. There are no particular components or adjustments that inspectors should monitor. More important than the machine itself, is the way it is operated.



Figure 7-47. Front-End Loader.

#### Identifying Data

The manufacturer's name, model number, and serial number of the loader should be recorded in the project folder. There are no stated specifications which must be met, but there should be a record that all equipment used on the project was inspected.

#### Visual Inspection

The power train, hydraulics, and lift mechanism should be inspected for leaks. The inside of the bucket should be viewed to ensure that it is in good condition and free from any substance which might contaminate the aggregate. A visual check of overall condition should be performed with particular attention given to any potentially harmful or unsafe condition.

## Section 8

### Heater and Storage Unit

#### General

Sometimes the contractor will set up a heater and storage unit for large projects. The asphalt is hauled from the source by truck and pumped into the heater and storage unit. When it is used, it is pumped either into another transporter or directly into the asphalt distributor.

There is no standard configuration for a storage and heater unit. It may be a tank with heating and circulating equipment combined, or it may be an insulated tank with a separate heater unit with interconnected piping. Storage capacity and size vary according to the needs of the project.

The heater and storage unit, usually called a heater unit, is inspected at the beginning of a project along with the other equipment. Sometimes the contractor has manufactured the heater unit, so there may not be any identifying data. The only numbers on the equipment may be an engine serial number on the pump unit.

#### Temperature

Asphalt must be stored at specific temperatures, which are usually somewhat higher than the temperatures at which the asphalt is applied. The asphalts used in seal coat work are stored at the following approximate temperatures:

Asphalt cement	325°F to 400°F
Cutback asphalt	150°F to 200°F
Emulsions	150°F to 170°F

The higher temperatures are the maximum allowable storage and heating temperatures.

In order for these asphalts to be sprayed properly, with the desired results, the temperature must be closely controlled in order to maintain the correct viscosity for spraying. The heater unit operator must clearly understand the importance of the viscosity-temperature relationship.

The heating and storage unit must be equipped with a continuous recording thermometer so that the temperature of the asphalt may be closely monitored.

#### Safety

The operator must be aware of the flash point (temperature at which ignition could occur) of whatever type of asphalt binder is being used. It is his responsibility to ensure that all necessary safety

precautions are taken, but this can never be assumed. The flash point is especially critical with cut-back asphalts. As an example, RC-250 has a flash point of 80°F. Standard Specifications Item 300.3 recommend that RC-250 be applied at temperatures between 125°F and 180°F. The maximum allowable temperature for application and storage is 200°F. With this type of asphalt, you are well into the dangerous range any time that you work with it.

There is also danger around the heater and storage unit, especially if using asphalt cement. Storage tanks, pipes, and valves are extremely hot. Adequate safety precautions should be taken to ensure that any part that might be touched is insulated.

Extreme care must be taken when obtaining a sample of asphalt cement. Very hot asphalt cement (350°F) can easily splatter. Proper safety equipment and clothing should be worn.

### **Storage Tank**

The storage tank must be inspected for cleanliness and the presence of any condition that would permit contamination of the asphalt. There should be a continuous-recording thermometer on the tank, which records any fluctuations in asphalt temperature.

### **Heater**

In some cases, the heater unit is a part of the storage tank. In others, it is a separate unit, consisting of a smaller tank with pump and heater. Regardless of the system used, the heater unit must be inspected.

It should have a burner that can be regulated to alter the intensity of heat. The burner should direct the flame into the flues, similar to the arrangement in an asphalt distributor. The pump should circulate the asphalt through the heater unit sufficiently to prevent the asphalt from burning next to the flues and from sticking (from cooling) near the outside of the tank.

### **Pump Unit**

The pump unit should be checked for proper operation, but the primary concern is to ensure that the pump and associated piping protects the asphalt from contamination. It should be assembled so that no dirt or fuel can enter the piping or pump unit.

### **Heater Unit Location**

Although the location of the heater unit is the contractor's responsibility, the inspector should consider the location of the unit from the standpoint of safety for the motorists.

The heater unit will have transporters moving to and from it, as well as asphalt distributors or boosters pulling onto and off the highway in the vicinity of the heater. This traffic must be clearly visible to motorists driving through the construction area. Therefore, it should not be situated on or near blind curves and probably well clear of intersections.

If the heater unit is situated in the vicinity of the aggregate stockpile, it should be separated far enough away to ensure that no contamination of the aggregate occurs. Asphalt is often spilled around heater units, so it is best that the heater be situated well away from aggregate stockpiles, if practical.

### **Recording Thermometer**

When the project begins, the inspector must pick up the record card from the continuous reading thermometer each day. A new card is installed when the old one is removed.

### **Transporter and Booster**

Transporters sometimes belong to the contractor, sometimes to the petroleum company that supplies the asphalt to the contractor, and sometimes to independent truckers. Booster tanks are not used on all jobs but are frequently used on projects that cover 6 to 10 miles or more. This cuts down on the amount of time the distributor is tied up while being refilled.

### **Identifying Data**

If the transporter and boosters belong to the contractor, record the standard vehicle identification information and include it in the project file. This would also apply if the contractor has leased the equipment.

If the transporter belongs to the petroleum company or to an independent trucker, record the company name and the truck license or other unique number. Although this may not be required, it is a good practice, in case there is a problem with the asphalt.

### **Manifest**

Check the transporter's manifest before it is unloaded to make certain the asphalt in the truck is the right type for the project. Unfortunately, some inspectors have found out too late that the wrong asphalt was pumped into the heater unit. Once again, this is the contractor's responsibility, but it will delay the project and can easily be prevented. A copy of the manifest of each load of asphalt delivered on the job must be retained in the project folder.

**Cleanliness**

If the transporter belongs to or is leased by the contractor, it should be cleaned if a different type of asphalt was transported on a previous project. It is not usually possible for the inspector to determine exactly what type of asphalt had been hauled previously, so a good rule of thumb is to be certain it is clean before it hauls asphalt to the current project.

**Contamination**

Besides guarding against contamination from previous asphalts, the inspector should ensure that the transporter tank and piping protect the asphalt from contamination during off-loading to the heater unit.

**Booster Tanks**

On some jobs, booster tanks are used to refill the distributors close to where asphalt application occurs. These vehicles should be inspected for cleanliness; to guard against contamination; and have the identifying data recorded. Their piping and shut-off valves should be checked for leaks to guard against puddles of asphalt being left behind after they have refilled an asphalt distributor. This is especially important if the distributors are to be filled while parked on the pavement that is to be seal coated.

Sometimes a transporter is used as a booster tank on the job, transporting asphalt from the heater unit to where the distributors are filled directly from the transporter. If asphalt cement (AC) is being shot on the project, it must be shot near 300°F. This would necessitate having an insulated transporter, in order to keep the asphalt hot between the heater unit and the distributor.

**Insulation**

Like the transporter, it may be necessary to ensure that booster tanks, if used to carry AC at high temperatures, are adequately insulated. Without proper insulation, the asphalt may cool enough to raise the viscosity above the limits for being pumped into the distributor, especially if there are any unexpected delays.

# Chapter 8

## Seal Coat/Surface Treatment Application Process

### Contents:

[Section 1 — Overview](#)

[Section 2 — Weather](#)

[Section 3 — Traffic Control](#)

[Section 4 — Removing Pavement Markers](#)

[Section 5 — Cleaning the Pavement](#)

[Section 6 — Placing Temporary Tabs](#)

[Section 7 — Setting the Rock Lands](#)

[Section 8 — Setting the Asphalt Shots](#)

[Section 9 — Checking the Loader Operation](#)

[Section 10 — Placing Paper Joints](#)

[Section 11 — Shooting the Asphalt](#)

[Section 12 — Strapping the Distributor](#)

[Section 13 — Spreading the Aggregate](#)

[Section 14 — Timing for Aggregate Application](#)

[Section 15 — Rolling the Aggregate](#)

[Section 16 — Patching or Hand Work](#)

[Section 17 — Intersections and Irregular Shapes](#)

[Section 18 — Brooming Excess Aggregate](#)

[Section 19 — Opening to Traffic](#)

[Section 20 — Temporary or Permanent Pavement Markings](#)

[Section 21 — Placing Raised Pavement Markers](#)

[Section 22 — Cleanup](#)

---

## Section 1

### Overview

#### General

In this chapter, we will describe the sequence of events during a full-width seal coat, strip/spot seal coat, or surface treatment application. It will include the following:

- ◆ Weather
- ◆ Traffic control
- ◆ Removing pavement markers
- ◆ Cleaning the pavement
- ◆ Placing temporary tabs
- ◆ Setting the rock lands
- ◆ Setting the asphalt shots
- ◆ Checking the loader operation
- ◆ Placing paper joints
- ◆ Shooting the asphalt
- ◆ Strapping the distributor
- ◆ Spreading the aggregate
- ◆ Timing for aggregate application
- ◆ Rolling the aggregate
- ◆ Patching or hand work
- ◆ Intersections and irregular shapes
- ◆ Brooming excess aggregate
- ◆ Opening to traffic
- ◆ Temporary or permanent pavement markings
- ◆ Placing raised pavement markers
- ◆ Cleanup.

In order for the seal coat or surface treatment to be applied as planned, it usually requires three inspectors. The application of the seal coat is a fast-paced process, and requires alert inspectors to ensure that it is done properly. The inspectors must work together as a tightly knit team, because it



is difficult to monitor every detail. If one inspector misses a detail, one of the others must pick it up. Communication and coordination must be excellent.

## Section 2

### Weather

#### Introduction

Weather plays an extremely important role in seal coat operations. There are many things that can result from a sudden change in weather, most of which are undesirable in seal coat work.

The best conditions for applying a seal coat or surface treatment are when temperatures are high, humidity is low, and there is little or no wind. In most parts of Texas, these conditions are most likely to occur from June through September. Too early in the spring or too late in the fall brings temperature and wind problems. The extended forecast should always be checked.

#### Temperature

[Item 316](#) of the Standard Specifications requires that seal coats and surface treatments be placed when the air temperature is above 50°F and rising. Seal coats and surface treatments may not be applied when the air temperature is below 60°F and falling. In all cases, no seal coat or surface treatment may be applied when the surface temperature is below 60°F.

If a polymer-modified asphalt cement is used, it shall be applied when the air temperature is above 70°F and rising and not when the air temperature is below 80°F and falling. Surface temperature must not be below 70°F. When wintertime work is allowed, the Engineer will approve the air and surface temperature for the asphalt application.

During the summer months, roadway temperatures are commonly 100°F or higher by 9 a.m. So in most cases, temperature is not a problem. An inspector must record the surface temperature every morning before any asphalt is shot. This can be done by placing a surface contact type of dial thermometer on the roadway. The temperature reading should be taken under conditions typical of those in which the asphalt will be shot.

#### Humidity

If possible, it is best if the asphalt is applied when the humidity is 50 percent or lower, especially when emulsions are used. With any type of asphalt a lower humidity is better. High humidity can cause an invisible film of moisture to collect on the roadway surface, which may interfere with the asphalt sticking properly to the surface. With emulsified asphalts, the emulsion will be slower to break in high humidity. With asphalt cement, which is shot at much higher temperatures than emulsions, steam can be seen rising as the hot asphalt hits the moisture on the roadway surface. As steam is trapped under the asphalt, small bubbles form and break as the air and moisture work their way to the asphalt surface.

## **Wind**

Wind can be both a disadvantage and an advantage. When an emulsion is used, a gentle wind of constant velocity can accelerate the breaking of the emulsion and allow traffic on the roadway sooner. If the wind varies or is too strong, it can distort the fan pattern as the asphalt is applied. This may cause streaking and uneven distribution. Contractors may install a shield in front of the spray bar to minimize wind effects on the spray pattern.

Wind also tends to blow asphalt onto passing vehicles. It is particularly important to be careful of wind direction when applying modified asphalt cements. Small “cobwebs” of asphalt are blown around and are almost invisible until they land on a light-colored vehicle. To minimize the effects of blowing asphalt, the sequence of work should be considered.

## **Rain**

No asphalt binders should be applied during rain. If rain is in the vicinity and predicted for the area, suspension of operations should be considered.

If an unexpected shower arises during operations, shut off the asphalt distributor immediately and continue placement of aggregate until all asphalt has been covered. This area should be rolled well and watched carefully after opening to traffic. After a rain, always suspend operations until the pavement has completely dried.

---

## Section 3

### Traffic Control

#### Introduction

Since safety is one of the most important concerns, all required traffic control devices must be in place and installed properly. All traffic control devices should conform to the details shown on the plans or those indicated in the Texas Manual on Uniform Traffic Control Devices ([TMUTCD](#)).

#### Pre-Positioning

For the operation to begin efficiently, the required barricades and signs should be in their proper locations no later than the day before the sealing begins. For strip/spot seal coat work, traffic control devices are normally placed on the day the work is performed. Generally, there should be one person who has full responsibility for traffic control. Traffic control includes erecting signs and barricades, placing traffic cones, flagging, and moving appropriate traffic control devices down the roadway as close as possible behind the seal coat equipment.

Project signing should be completed before beginning any seal coat work. Signs should be covered until they become effective and removed when no longer needed.

#### Displaying Signs

Before any work begins and before any equipment is moved onto the highway, all of the required traffic control devices must be:

- ◆ In the proper sequence
- ◆ The correct distance and spacing leading up to the work
- ◆ Clearly visible to motorists
- ◆ Positioned correctly so the devices do not pose a hazard to traffic.

#### Traffic Cones

Traffic cones are typically used to keep traffic routed around the seal coat work area as shown in Figure 8-1. Traffic cone placement must be checked to ensure:

- ◆ Sight distance is adequate prior to lane closure
- ◆ Proper spacing and taper lengths
- ◆ Cones are placed past the distance of the first asphalt shot
- ◆ Cones are placed outside the operating path of the asphalt distributor and aggregate spreader.



Figure 8-1. Traffic Cones in Position.

### Flaggers

When flaggers are required, each flagger must be properly trained or certified. Ensure the flagger is using proper equipment, correct signals, and can verbally explain the situation to vehicle operators. If there are flaggers at both ends of the project, ensure they have adequate communication devices and that the devices are used properly. The flaggers are vital to the safety of motorists in the work area. If the flaggers are not performing their duties properly, they must be corrected promptly.

### Pilot Vehicle

A pilot vehicle and radio equipped flaggers are often used for undivided roadways to improve the safety of the traveling public through a seal coat project. As a minimum, a pilot vehicle should have appropriate signing on the rear of the vehicle to guide the traveling public through the seal coat project.

### Repositioning Traffic Control Devices

As work progresses down the roadway and as sections are opened to traffic, appropriate traffic control devices and flaggers should be repositioned. Once the flaggers and appropriate traffic control devices have been repositioned, they should be checked again to ensure proper placement and procedures.

### Intersections

If the seal coat operation crosses intersections, traffic in these areas must be controlled. Care must be taken to prevent vehicles from crossing the asphalt before the aggregate is placed. This may require positioning other members of the traffic control crew at the intersection.

## **Arrow Boards**

Arrow boards are often used to move traffic into the adjacent lane. These are especially used on four-lane highways and where there is a large volume of high-speed traffic.

## Section 4

### Removing Pavement Markers

#### General

If directed, raised pavement markers should be removed from the pavement and disposed of properly in preparation for seal coat work. The best time to remove pavement markers is early in the day when temperatures are cooler. This can be accomplished with a motor grader, front-end loader, or other acceptable methods. Figure 8-2 illustrates a motor grader removing pavement markers. If pavement becomes damaged due to marker removal, pavement repair may be necessary. If marker removal is consistently causing pavement damage, consult with the appropriate engineer. [Item 677](#), Eliminating Existing Pavement Markings and Markers, of TxDOT's Standard Specifications, governs this function.



*Figure 8-2. Removal of Raised Pavement Markers.*

## Section 5

### Cleaning the Pavement

#### Introduction

The pavement should be cleaned and swept prior to, but not too far in advance of, the asphalt application. Cleaning should include removal of any vegetation and soil on the edge of the pavement. Sweeping is especially important under dusty conditions.

#### Safety During Sweeping Operations

Since the sweeper operates a considerable distance ahead of the other seal coat equipment, it is very critical that the sweeper is equipped with appropriate warning devices. Motorists do not always stay on the proper side of the traffic cones, or they may enter the roadway from a private drive or side road. The sweeper may sometimes create so much dust that visibility is reduced. When visibility is reduced, a flagger may be required.

#### Sweeping Pattern

Normally the sweeper will require two to three passes to adequately prepare a 12-foot lane. It is preferable that each pass progresses toward the shoulder. Certain wind conditions or other unique situations could require a different pattern; however, it is always best to broom away from traffic and with the wind whenever possible.

#### Sweeping Distance from Operation

The sweeping operation should be far enough ahead that the sealing operation is never held up waiting for the sweeper. If conditions are very dusty, sweeping should not be more than one or two shots ahead of the asphalt distributor to prevent dust accumulation between the sweeper and the asphalt distributor. Additional sweeping may be required where dust or dirt is tracked onto the pavement from side roads or private access roads. Hand work may be required.



## Section 6

### Placing Temporary Tabs

#### General

Prior to shooting asphalt, temporary flexible-reflective roadway marker tabs should be placed to designate lane lines in accordance with applicable traffic control plans. Placement of temporary tabs is governed by TxDOT's Standard Specifications [Item 662](#), Work Zone Pavement Markings.

## Section 7

### Setting the Rock Lands

#### Introduction

A rock land is the area covered, at the desired aggregate application rate, by one predetermined size truckload of aggregate. The area of the rock land is calculated in advance and marked either on the pavement with paint or on the side of the road with flags. Setting rock lands for strip/spot seal coat work is not necessary if less than one truckload of aggregate will be used in a particular area.

#### Purpose

The rock lands are usually set at the start of a project to help the contractor calibrate the spreader box and assure that the correct aggregate rate is being applied. If the aggregate runs out before reaching the marker at the end of the rock land, the rate is too heavy. If there is aggregate remaining at the end of the rock land, the rate is too light. This is based on the assumption that the truck is carrying the predetermined amount of aggregate.

#### Calculating the Length of Rock Land

The desired rate of aggregate application is specified as 1 cubic yard of aggregate for a given number of square yards of roadway, such as 1 CY/125 SY.

For example, assume that the lane to be sealed is 12 feet wide, and the haul truck is filled with 14 cubic yards of aggregate. The desired application rate is 1 CY/125 SY.

Area of Rock Land	$14CY \times 125SY / CY = 1750SY$
Length of Rock Land	$(1750SY \times 9SF / SY) / 12ft = 1313LF$

#### Marking the Rock Lands

Using a calibrated Digital Measuring Instrument, start at the beginning of the first shot with the DMI set at zero. Drive down the roadway until the DMI reads the calculated length of rock land. Stop and mark the end of the rock land. Make certain that the markings for rock lands are a different color or are somehow distinguishable from the markings used for the asphalt shots. Reset the DMI at the end of each rock land, and repeat the process.

## Section 8

### Setting the Asphalt Shots

#### Introduction

An asphalt shot must be equal to the length of a specified number of full rock lands. For example, one asphalt shot should equal 1, 2, or 3 rock lands, not 1.7 rock lands. The area of the asphalt shot is calculated in advance and marked either on the pavement with paint or on the side of the roadway with flags. Marking asphalt shots in advance provides a way to check the asphalt application rate. Setting the asphalt shot for strip/spot seal coat work is not necessary if less than one truckload of aggregate will be used in a particular area.

#### Asphalt Application Rate

The asphalt application rate shown on the plans is intended primarily for estimate purposes. The actual application rate should be based on several design variables as discussed in Chapter 4.

If asphalt cement is to be applied at 0.36 gallons per square yard, this rate should be sprayed from the distributor. If emulsion is to be applied at a residual rate of 0.36 gallons per square yard, this is the residual amount of asphalt desired and not the amount to be shot from the distributor.

Emulsions consist of asphalt cement, water, and an emulsifying agent. After the emulsion is sprayed on the roadway, the water evaporates (the emulsion breaks), leaving only the asphalt cement. Various types of emulsions contain different amounts of water and emulsifiers. Typically, an emulsifying agent and water are 35 to 40 percent of the total emulsion. Therefore, an emulsion to be applied at a residual rate of 0.36 gallons per square yard with 60 percent residual asphalt should be sprayed at a rate of 0.60 gallons per square yard ( $0.36/0.60$ ). The percentage of residual asphalt for any emulsion can be obtained from the district asphalt laboratory or the emulsion supplier.

#### Distributor Capacity

The capacity of the asphalt distributor must be considered when setting the asphalt shot. A distributor should never be completely emptied in an asphalt shot. This is especially important when shooting emulsions because emulsions tend to foam more than other types of asphalt, and the operator should stop spraying before the foam is reached. For a 2000 gallon distributor, it is good practice to leave at least 200 gallons in the distributor at the end of each emulsion shot or 100 gallons if AC is used. Recirculation of the remaining binder through the spray bar also reduces the chance that the thin film of asphalt remaining inside the pipes and spray nozzles will harden due to rapid cooling.

### Calculating the Length of Asphalt Shot

The asphalt shot length should be based on full rock lands, which are governed by the number and size of trucks available. For example, assume one 12-foot wide section of roadway is to be sealed with AC at 0.36 gallons per square yard using a 2000-gallon distributor and haul trucks with a capacity of 14 cubic yards.

Desired Asphalt Rate	0.36 gal/SY
Distributor Capacity	2000 gal
Area of Rock Land	1750 SY (calculated in Section 7)
Length of Rock Land	1313 LF (calculated in Section 7)
Gallons per Rock Land	$0.36 \text{ gal/SY} \times 1750 \text{ SY} = 630 \text{ gal/rock land}$
Rock Lands per Shot	$2000 \text{ gal (distributor capacity)} / 630 \text{ gal}$ = 3.2 rock lands
Note: Shot length must be in full rock lands and should leave at least 100 gallons of AC in the distributor.	
Gallons per Asphalt Shot	$3 \text{ full rock lands} \times 630 \text{ gal/rock land}$ = 1890 gal
Gallons Left in Distributor	$2000 - 1890$ 110 gal (greater than 100 gal, OK)
Length of Asphalt Shot	$3 \text{ full rock lands} \times 1313 \text{ LF} = 3939 \text{ LF}$

### Marking the Asphalt Shot

Using a calibrated DMI, start at the beginning of the first shot with the DMI set at zero. Drive down the roadway until the DMI reads the calculated length of asphalt shot. Stop and mark the end of the asphalt shot. Make certain that the markings for the asphalt shot are a different color or are somehow distinguishable from the markings used for the rock lands. A bright fluorescent spray paint can be used on the pavement or a small, bright-colored wire flag may be stuck in the soil next to the pavement surface. Reset the DMI at the end of each asphalt shot, and repeat the process. By marking each shot, the contractor will know where to form a paper joint, which will be discussed later.

**Note:** Do not apply asphalt to the roadway until the haul trucks are loaded with enough aggregate to cover the asphalt shot area, and the haul trucks are in place behind the aggregate spreader box. It is also critical to ensure that the production rates of the asphalt distributors, spreaders, and rollers are matched. Please refer to [Section 15](#) for additional information on matching production rates.

## Section 9

### Checking the Loader Operation

#### Introduction

The loading of aggregate from stockpiles into the haul trucks is very important to the success of a seal coat application. This operation is sometimes overlooked because it is somewhat removed from the center of activity. Every effort should be made to watch the loader operation activity early in the project and spot-check it periodically thereafter.

#### Loader Operation Checklist

**Gradation.** The loader operator should take a representative scoop of aggregate with each bucket. Graded aggregate will tend to segregate somewhat when it is stockpiled. Finer particles tend to sift between the coarse particles, making the stockpile show a greater content of coarse particles near the top and outside. The bucket on the front-end loader should penetrate the stockpile near the bottom and penetrate deeply enough to have a full range of the aggregate gradation.

**Contamination.** The loader operator usually tries to use every bit of aggregate available on the stockpile. In doing so, the bucket may scrape too close to the bottom of the stockpile allowing clay balls or grass to be picked up along with the aggregate. Aggregate containing contaminants should not be used. If there is grass, clay, or soil being placed in the spreader box, the loader operation must be corrected immediately.

**Degradation.** The loader should be operated carefully to avoid degradation of the aggregate. The operator should not operate the equipment in such a manner that causes the front wheels to roll over any of the stockpile. This will cause the larger pieces to be crushed into smaller particles changing the aggregate gradation.

**Full Trucks.** The operator should fill every truck to its predetermined calibrated level. This will ensure that the contractor is paid for the correct amount of aggregate, and the aggregate is applied at the desired application rate.

**Excessive Dust.** Sometimes projects can have problems with excessive dust in the aggregate stockpile. If a cloud of dust occurs with every bucket load that is placed in the trucks, the dust may be detrimental to the seal coat performance. If dust is a problem, it may be reduced by lightly sprinkling the stockpile with water. Only enough water should be used to reduce the dust, and this is only recommended when emulsions are being used.

## Section 10

### Placing Paper Joints

#### Introduction

To ensure an even, straight, and sharp beginning and end of each asphalt shot, paper joints should be placed. Paper joints may or may not be needed for strip/spot seal coat work.

#### Equipment

The most efficient method of placing paper joints is to have two people with a truck assigned to this responsibility. This crew will need a small load of aggregate, shovels, push brooms, and a large roll of heavyweight brown paper or other approved material (36 to 48 inches wide).

#### Beginning of Asphalt Shot

At the beginning of an asphalt shot, a strip of paper should be placed across the full width of the lane being sealed and anchored down with a small amount of aggregate spread over the paper. If the distributor operator is inexperienced, a wider mask of paper may be needed. A second or third sheet of paper can be placed adjacent to the first, overlapping each one by at least 2 or 3 inches.

Any aggregate that has spilled onto the pavement surface should be swept away. As soon as the distributor has started the shot, the paper should be removed. Figure 8-3 shows a typical paper joint being placed.

#### End of Asphalt Shot

At the end of the asphalt shot, another paper joint must be placed. It is placed just like the first joint except that the rear edge of the paper is placed on the mark for the end of the shot. The asphalt distributor sprayer will be turned off as the spray bar passes over the paper.



Figure 8-3. Placing a Paper Joint at Beginning of Shot.

### Subsequent Asphalt Shots with Multiple Distributors

As soon as one distributor has completed an asphalt shot, the paper joint should be pulled to the side of the road and disposed of later. Before the next distributor begins the next shot, aggregate should be spread by shovel over the fresh asphalt where the paper joint is to be placed for the starting joint of the next shot. Another paper joint is placed over the end to form a starting joint for the next shot.

Care must be taken to clean all excess aggregate off the unsealed pavement to preserve the clean, sharp end. The edge of the paper should be positioned exactly above the end of the asphalt shot as shown in Figure 8-4.



*Figure 8-4. Paper Joint in Place at Beginning of Second Shot.*



## Section 11

### Shooting the Asphalt

#### Introduction

The asphalt distributor is a complex piece of equipment. For a smooth operation, the equipment must be in good working condition and the correct procedures must be followed.

#### Distributor Preparation

Heating asphalt binder always constitutes some degree of hazard, with the exception perhaps of emulsions. The most hazardous are cutback asphalts because of the highly volatile solvents used. Extreme care must be taken not to allow open flames to come in contact with the cutback asphalt or the gases from hot cutback asphalt. When working with asphalt cement, the major safety concern is related to the high temperature of the binder. Contact with asphalt cement at 300°F will cause severe burns.

When switching from one type of asphalt binder to another in the same asphalt distributor, thoroughly flush or clean out the previous binder from the system. This will minimize contamination of the new binder and enhance safety of the seal coat operation. When switching from emulsion to AC, the distributor should not be filled to more than half full for the first two or three asphalt shots to minimize foaming and possible overflow via the manhole of the tank. Emulsion in the spray bar is sufficient to cause foaming and tank overflow when the hot asphalt cement is circulated through the spray bar. Switching from cutback asphalt to AC can create a potential explosion hazard, and extreme caution should be exercised.

The distributor must be filled from the heater unit, booster tank, asphalt storage tank, or transporter as shown in Figure 8-5.



Figure 8-5. Transferring Asphalt from Transporter to Distributor.

When the distributor is full, the number of gallons must be recorded. A strap stick should be used to measure the gallons as described in [Section 12](#).

The asphalt temperature in the distributor must be checked to ensure that it is within the recommended application temperature range. If the temperature is low, the operator should light the burners of the heater unit and start the pump to circulate the asphalt through the pipes. It is also important for the spray bar to be hot. Circulating the asphalt through the system should heat the bar adequately.

The operator should increase the pump speed to make certain the correct pressure is set for the asphalt to be applied. This is important on the first shot of the project, even though the distributor was inspected earlier. It should also be done on the first shot each morning.

### **Blow the Nozzles**

The distributor should be moved to the side of the road until the correct shooting temperature is reached. When the asphalt has reached the correct temperature and the spray bar is completely off the pavement and in a flat area, one or two layers of joint paper should be placed under the spray bar and the sprayer should be turned on momentarily to “blow out” the nozzles. While spraying, each nozzle should be visually checked to make certain no nozzles are clogged and the spray pattern looks correct.

If any nozzles are clogged, they should be removed and cleaned out with an appropriate solvent. After cleaning any nozzles as needed, the nozzles should be blown out, and the spray pattern should be checked again. The spray system should be checked for leaking asphalt. If no leaks are apparent and all nozzles are working correctly, the distributor may be moved into position at the beginning of the asphalt shot.

### Check Spray Bar Height

To check the spray bar height before applying the asphalt, refer to [Chapter 7 Section 3](#). The distributor should stand by in a ready position while other final equipment checks are made.

### Final Equipment Check

A final check must be made to ensure that all the other equipment is in position and ready before allowing any asphalt to be sprayed. The aggregate spreader box should be in position and ready to begin. The required number of haul trucks needed to cover the asphalt shot must be in position behind the spreader box. If a patching crew will be used on the job, they should be ready to follow the haul trucks as closely as possible. All the rollers should be ready to begin.

### Paper Joint Check

The paper joint should be in place for the beginning and the end of the asphalt shot. It should be of adequate width for the type of distributor being used and the skill of the operator. The distributor spray bar should be positioned over or behind the paper joint for the beginning of the asphalt shot. This will enable the spray bar nozzles to be opened on the paper joint at the beginning of the asphalt shot. Figure 8-1 shows the correct position for the distributor.



Figure 8-6. Correct Starting Position over Paper Joint.

### Transverse Alignment

When the distributor is in position over the paper, the transverse alignment should be visually checked. The end nozzle should be directly over the line, which the operator will use as a guide. As soon as the transverse alignment is correct, the operator should set the guide bar so that alignment is in position over the reference line.

## **Applying the Asphalt**

As soon as all the preceding checks have been made, including strapping the distributor, the application of asphalt may begin. The inspector should be in position to closely observe the early part of each shot to see that the fan pattern is correct and all nozzles are spraying properly. The asphalt applied on the roadway surface should be closely inspected to detect any variation. It should appear as a uniform sheet of asphalt across the entire width of the shot. If any streaking, ridging, puddling, or flowing of asphalt off the roadway surface is observed, the operation should be stopped immediately and corrections made.

After completion of the asphalt shot, the distributor should be strapped as described in [Section 12](#).

## **Timing for Aggregate Application**

For best results, aggregate should be applied on any type of asphalt binder as soon as possible without causing the rocks to turn over or the asphalt to be picked up on spreader box, haul truck, or roller tires. That is, the aggregate spreader should follow closely behind the asphalt distributor. Refer to Section 14 for more information on spreading the aggregate.

## **Additional Distributors**

If additional distributors are used, make certain that the same checks are performed on all distributors. If the distributors are identical they should be numbered so that they can be easily distinguished.

## Section 12

### Strapping the Distributor

#### Introduction

Before and after each distributor load of asphalt is sprayed, the asphalt distributor should be strapped. The term “strapped” means a calibrated measuring stick is used to measure the asphalt in the tank. For strip/spot seal coat work, generally the asphalt distributor should be strapped before and after all work is completed for each roadway or at the end of the day, whichever occurs first. When using a computerized asphalt distributor for strip/spot seal coat, the asphalt quantity can be obtained from the gauges on the equipment and strapping is only necessary for calibration purposes.

If payment is by volume, it is necessary to strap the distributor to keep an accurate record of the amount of asphalt that is used on the project. If payment is by weight, the distributor must be strapped to verify the application rate.

#### Determining Asphalt Application Rate

Strapping the distributor is important for pay purposes and also for determining the average asphalt application rate for each shot. This allows for immediate information needed to make adjustments from one shot to the next. The following procedure may be used to strap the distributor:

- ◆ Immediately before and after the asphalt shot, the operator should stop the distributor on a level spot. The tank must be as level as possible. Some distributors have a level attached to the tank. If not, a 3 to 4-foot carpenter’s level may be used.
- ◆ The strap stick should be clean so that the level of asphalt can be easily read. The manhole cover at the top of the tank should be opened, and the strap stick inserted into the tank holding it as nearly vertical as possible.
- ◆ The strap stick should be lowered down into the asphalt until it touches the bottom of the tank.
- ◆ The strap stick should then be removed from the tank. The number of gallons is read at the top of the line covered by asphalt. On some distributor models, the strap stick itself is not graduated and must be held up against a graduated scale mounted on the side of the tank.

Example:

Area of Asphalt Shot	5625 SY
Gallons before asphalt shot	2000 gal
Gallons after asphalt shot	225 gal

Gallons used for asphalt shot	$2000 - 225 = 1775 \text{ gal}$
Average application rate	$\frac{1775 \text{ gal used}}{5625 \text{ SY}}$ $= 0.315 \text{ gal/SY}$

## Section 13

### Spreading the Aggregate

#### Introduction

The aggregate spreader and all other equipment must be in position and ready to begin before the distributor applies the asphalt shot. The required number of haul trucks needed to cover the asphalt shot must be in position behind the spreader box. If a patching crew will be used on the job, they should be ready to follow the haul trucks as closely as possible. All the rollers should be ready to begin.

For strip/spot seal coat work, a dump truck tailgate spreader is commonly used for spreading the aggregate instead of a self-propelled spreader box.

#### Aligning the Spreader Box

As the distributor begins to apply the asphalt shot, the spreader should move to within a few feet of the starting point. While the joint paper is being removed, the operator should align the spreader.

Once the spreader is in position, the operator should make sure that all of the necessary discharge gates are open to ensure complete coverage of the asphalt shot. If the discharge hopper is wider than the asphalt, some of the gates must be closed.

#### Truck Hookup

The waiting haul truck should back up to the aggregate spreader and stop slightly short of coming in contact with the spreader. This allows the spreader operator to back the spreader into the truck, so that the hitches connect. A spotter should be used to ensure correct connection.

The haul truck transmission should be in neutral to allow the spreader to tow the truck backwards as the aggregate is spread. Upon signal from the spreader operator, the truck tailgate latch should be released. The truck bed is raised allowing the aggregate to fill the receiving hopper. The haul truck driver must remain ready to lower the bed on signal to prevent the hopper from overflowing.

As soon as the aggregate begins to pour into the receiving hopper, the conveyor belts should be engaged. The aggregate begins to flow into the discharge hopper and is distributed across the discharge gates. When both the receiving and discharge hoppers are nearly full, the spreader operator, or his assistant, signals the truck driver to lower the truck bed to stop the flow of aggregate into the spreader.

## Test Strip

Before any asphalt is applied, a short test strip may be applied on bare pavement to visually check for uniform aggregate coverage. If a test strip is to be applied, the spreader operator may disengage the truck hitch and have the truck move away from the spreader. This allows the spreader operator to test his equipment for a few feet without the truck being attached. There should be enough aggregate in the spreader to run perhaps a 50-foot test strip. Any gates not functioning properly should be corrected. Once the spreader gate settings are correct and the equipment is functioning properly, the test should be terminated.

## Spreading the Aggregate

If the truck was disengaged from the spreader to perform a test strip, the truck and spreader should be joined together again. As the spreader and truck move forward, the gates should be opened just before reaching the beginning of the asphalt shot. The truck bed should be raised enough to keep the receiving hopper full until the truck bed is empty.

For best results, aggregate should be applied on any type of asphalt binder as soon as possible without causing the rocks to roll over or the asphalt to be picked up on spreader box, haul truck, or roller tires. That is, the aggregate spreader should follow closely behind the asphalt distributor. Refer to [Section 14](#) for more information on the proper time to begin spreading the aggregate.

Once the truck bed is empty, a signal should be given to lower the truck bed. This will allow the truck to separate from the spreader without causing the tailgate or rear of the truck bed to strike the top of the receiving hopper.

## Truck/Spreader Separation

The spreader will normally continue to move forward while the truck bed is being lowered. Before the spreader is completely empty, the operator should release the truck. Most hitches can be released without stopping the spreader, but the spreader must eventually stop to hook up to the next truck. After the spreader stops, it should be backed up a few feet to allow the second truck to link up. The process is then repeated.

## Rock Land Marker

After hooking up with the second truck and resuming the spreading, the spreader should pass the marker for the end of the first rock land. The end of the first rock land should be slightly farther than the second truck hookup, because there should be some aggregate in the spreader remaining from the first truckload.

If the spreader passes the first rock land marker before the first truck is empty, the aggregate is being applied too thinly. If the second truck is hooked up more than 25 feet before the first rock



land marker, the aggregate is being applied too heavily. In either case, gate openings must be adjusted accordingly.

### Visual Checks

The inspector assigned to watch the aggregate application should be positioned to have a good view of the aggregate as it leaves the discharge hopper. There should be a thin “curtain” of aggregate dropping through the gates. The curtain should be uniform across the entire width of the discharge hopper. The curtain of aggregate should be only one aggregate particle thick, and light should be easily seen through the curtain. Any dark streams suggest a gate is open too wide. Any unusually light streak means not enough aggregate is being released. If the aggregate appears to be stacking as it is placed on the asphalt, it is being applied too heavily.

The scalping grate on top of the discharge hopper should also be visually checked. There should be a steady flow of aggregate passing through it. An accumulation of clay balls, grass, or rocks on top of the grate indicates that the loader operator is picking up contaminants. This problem should be corrected immediately.

Behind the spreader, the pavement surface should be checked for contaminants and streaking of thin or thick rows of aggregates. If there is evidence of thick and thin alternating streaks running transversely (a ripple effect), it indicates that the spreader speed is too high.

### Recording Truck Loads

It is important to keep accurate records of the number of truck loads of aggregate placed on the roadway. One method is to write down the identification numbers of each truck on the project. Each time a truck finishes emptying a load into the spreader, a mark is placed beside that truck’s number.

### Asphalt on Tires

Occasionally, the tires on the spreader and the haul trucks should be checked for asphalt (and aggregate) sticking to them. This should be corrected immediately.

The following conditions may cause tires to pick up asphalt:

- ◆ Aggregate is rolling over causing asphalt to be exposed to the tires. This can be caused by not using enough asphalt to hold the aggregate or by applying too much aggregate. Refer to [Section 14](#) for more information on the proper time to begin spreading the aggregate.
- ◆ Too much asphalt has been applied.
- ◆ A puddle of asphalt may have leaked or spilled onto the pavement without cleanup prior to aggregate application.

- ◆ One of the discharge gates on the spreader may have clogged momentarily, preventing the aggregate from covering the asphalt.
- ◆ Failure to use deflector nozzles and overlapping the shot in the second lane causes an excess of asphalt.
- ◆ Detouring traffic onto the fresh seal may cause aggregate pickup.
- ◆ Construction and other traffic accelerating, turning, and braking abruptly on the fresh seal can dislodge aggregate. Accelerating quickly may cause a tire to spin because of the soft asphalt and unrolled aggregate. Turning quickly may cause the aggregate to roll over, exposing some of the asphalt. Braking suddenly may cause the wheels to lock and shove aggregate. These situations can occur with any asphalt but are most likely to occur when using asphalt emulsions.
- ◆ Improper tire inflation pressures on construction vehicles.

If any of the above situations occur, the seal patching crew should repair the spot before rolling. Tires should be cleaned immediately and the condition remedied before the situation gets worse.

## Section 14

### Timing for Aggregate Application

#### Introduction

This section is intended to provide guidance for determining the proper time to begin applying aggregate on fresh asphalt. The following paragraphs will address applying aggregate as soon as possible.

#### Immediate Aggregate Application

**For best results**, aggregate should be applied to emulsified asphalt or hot AC immediately. That is, the aggregate spreader should follow closely behind the distributor. Applying the aggregate while the asphalt is very liquid maximizes aggregate embedment depth and aggregate-to-asphalt adhesion and thus enhances quality and economics of the seal coat. As the emulsion breaks or cures, the residue is deposited up the sides of the aggregate particles, and a meniscus is formed as shown in Figure 8-7.

### *Before Curing:*

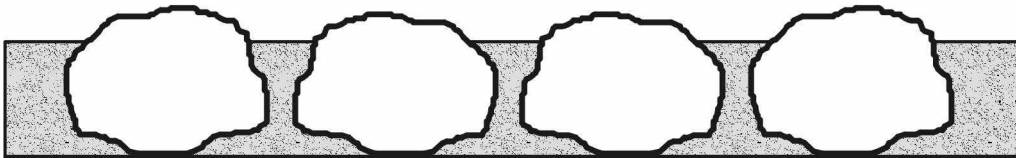

### *After Curing:*



Figure 8-7. *Decrease in Volume after Emulsion Has Cured.*

This cannot occur with cool AC or emulsion after it breaks. High embedment depth minimizes shelling, particularly when the seal coat experiences rain or cold weather shortly after placement. One reason for using emulsified asphalts is that they typically require less residual asphalt than hot AC when the aggregate is properly applied to achieve adequate embedment depth.

When applying emulsions for seal coats, many crews wait until the emulsion begins to break before applying the aggregate. Similarly, when applying hot AC, they wait until it cools before applying the aggregate. They do this because when they apply the aggregate to the fresh (very liquid) emulsion or hot AC, the aggregate particles strike the pavement surface and bounce or roll forward often coming to rest with a coating of asphalt on the upper surface of the aggregate particle. Subsequent aggregate seating using a pneumatic roller may pick up some of those aggregate particles with a sticky asphalt coating on top and thus create major problems during the rolling process.

Waiting for the emulsion to break or the AC to cool before applying the aggregate often results in undesirable subsequent circumstances.

- ◆ The first is very low embedment depth. When emulsified asphalts begin to break, particularly polymer-modified emulsions, they often form a skin on the surface. This skin prevents adequate embedment of the aggregate particles into the emulsion layer and reduces aggregate-to-asphalt adhesion. Allowing AC to cool before applying aggregate causes similar problems.
- ◆ Low aggregate embedment depth and poor adhesion present the potential for shelling, particularly for seal coats placed late in the season, just before fall rains and cool weather begins.
- ◆ To offset the potential for aggregate shelling, the emulsion or AC application rate is often increased, particularly late in the season, when there is concern about shelling. This excess asphalt may cause flushing during the following summer.

Aggregate roll-over is **not** a result of low viscosity of the emulsion or hot AC, but it may be caused by the forward motion (horizontal velocity component) of the aggregate particles when they strike the pavement surface. One possible solution may be a strategically located “striker plate” fastened to the aggregate spreader at the appropriate angle to redirect the aggregate so that it falls essentially straight downward onto the pavement surface without bouncing or rolling forward. That is, the aggregate particles should have no forward motion during application. Once the striker plate is in place and the proper speed has been determined to cause the aggregate to drop straight downward, the aggregate spreader should always be operated at that predetermined speed. Some late-model aggregate spreaders are designed to apply the aggregate with no forward momentum.

## Section 15

### Rolling the Aggregate

#### Introduction

The aggregate should be rolled immediately with approved self-propelled pneumatic-tired rollers. Steel-wheeled rollers are not recommended because they can crush the aggregate. Immediate rolling provides better embedment and assists rapid wetting of the aggregate by the binder. There should be enough rollers to cover the entire mat width in one pass (one direction). Rolling should be in a staggered pattern making a minimum of five passes for asphalt cement or three passes for asphalt emulsions. Additional rolling may be required during cooler air temperatures. If rollers are unable to keep up with the spreader, asphalt application should stop until rollers catch up, or additional rollers should be furnished.

The distributor controls the overall production because no other piece of equipment can begin to function until the distributor has applied binder to the surface. Therefore, to ensure a high standard of quality control, the spreader and roller operations must be able to keep up with the production of the distributor. The number of rollers, the rolling time, and keeping pace with the distributor are critical for a successful seal coat.

#### Rolling Pattern

The rolling pattern used for seal coats will depend largely on the number and types of rollers. For a 12-foot wide asphalt shot, the most efficient rolling system will typically involve three or four pneumatic rollers. With this number of rollers, it is possible to provide coverage with three passes (acceptable for emulsions): one forward, one in reverse, and the final pass forward extending into the first pass of the next section. It is usually better to have the rollers operating continuously rather than sitting idle. Normally, more rolling is better unless aggregate degradation is occurring.

When three or four pneumatic rollers are used, the rollers should be staggered in an echelon pattern. The lead roller is usually on the inside, and each of the others offset approximately one-third the roller width. The sketch in Figure 8-8 illustrates the echelon pattern.

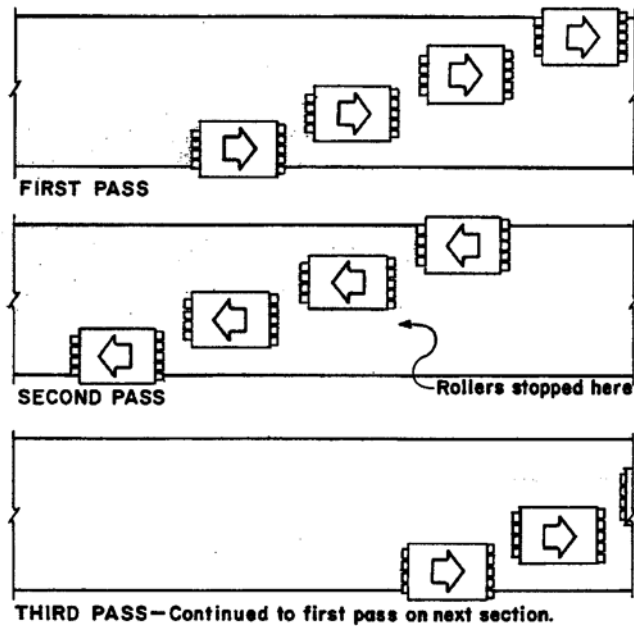

Figure 8-8. Illustration of Echelon Rolling Pattern.

### Checking the Rolling Pattern

The rolling pattern should be checked to verify that complete coverage and proper embedment are achieved. Rollers should cover both edges completely as well as the center of the lane. After the rollers have completed one section, the aggregate orientation should be visually evaluated. If the aggregate particles are lying in their flattest dimension, the rolling is adequate. If many of the aggregate particles are still situated upright, additional rolling should be required. The rolling operation should be monitored carefully to ensure that none of the roller operators stop and start too quickly causing scuffing on the fresh seal.

## Section 16

### Patching or Hand Work

#### Introduction

There are many things that can occur during the seal coat operation requiring some minor patching or hand work. A crew of two or three people is sometimes assigned the responsibility for patching. They should be equipped with a pickup containing a supply of aggregate, shovels, push brooms, and sometimes buckets with patching asphalt and swabs or mops to apply it. They usually follow behind the chain of haul trucks and make repairs before the rollers reach the troubled spot.

#### Immediate Repairs

The patching crew may be required to make minor, on-the-spot repairs that will not interrupt the seal coat process. These repairs may include the following:

- ◆ Removing and/or brooming small mounds of excess spilled aggregate on top of the sealed surface. The majority may be shoveled back into the truck and the remainder swept to the side of the shoulder.
- ◆ Occasionally a double layer of asphalt may be sprayed on a joint. This usually happens because the joint paper was not exactly at the edge of the aggregate when a joint was made. Asphalt may ooze up through the aggregate at this point. All the patching crew can do is cover the asphalt with additional aggregate to prevent it from sticking to the roller tires. Later, it should be removed and the section replaced. Otherwise, there will be a noticeable bump.
- ◆ Sometimes asphalt splashes outside the coverage of the spreader. These streaks of asphalt must be covered with aggregate so the asphalt will not stick to the roller tires.
- ◆ Removal of grass or clay balls. If the patching crew finds any grass or clay balls that have passed through the spreader, it is their responsibility to remove the contaminants and replace with aggregate.
- ◆ If a spot has been missed by the asphalt distributor because of a clogged nozzle, or any other reason, the patching crew should apply asphalt on the bare spot followed by aggregate.

#### Delayed Repairs

Some repairs are beyond the capability of the patching crew and must be delayed until later. These are usually large areas that have failed for various reasons. The method of repair for these large areas should be determined after discussion with the engineer.

## Section 17

### Intersections and Irregular Shapes

#### Introduction

In general, intersections and irregular shapes should be seal coated before the main lanes. This will minimize aggregate loss due to turning movements from construction equipment and provide a sharp longitudinal joint.

#### Transitions

Transitions are shot in a similar manner to shoulders. It is good practice to start at the narrow end, whenever possible. Then as the surface widens, one or two nozzles can be turned on quickly at the right time. If progression is toward the narrow end, there is more potential for overspray error. There are cases where it is not practical to start at the narrow end.

In some cases, transitions may require some touch-up with the hand sprayer in order to even up the outside edge. The inside joint at the full lane should be straight and sharp. The outside edges can be touched up easier than a ragged joint.

#### Radii at Intersections

To seal the radii at intersections, apply the asphalt with the distributor hand sprayer and apply the aggregate with the spreader or by hand.

#### Crossovers on Divided Highways

Sealing the crossovers on divided highways normally entails a combination of techniques used for transitions and intersection radii.

#### Driveways and Private Roads

Driveways and private roads, which provide access to the highway, are not normally sealed even though they are within TxDOT's right of way.

#### Problems with Hand Work

Anytime that hand spraying and manual aggregate spreading is required, achieving uniform application rates will be difficult. It is desirable to keep hand work to a minimum. Any lack of uniformity will usually result in some type of problem, either immediately or in the future.



## Section 18

### Brooming Excess Aggregate

#### Introduction

After the aggregate is spread and rolled, there will be some loose aggregate. This excess aggregate should be removed to prevent it from being whipped up by vehicle tires. Loose material may act to dislodge other aggregate under traffic shear forces.

#### Timing

The excess aggregate should not be broomed off the roadway as soon as the rolling is finished. The asphalt is still too soft and must be allowed to stiffen or cure before brooming. Otherwise, the broom will strip the aggregate away from the binder. If necessary, **light** brooming may be performed before opening to traffic to remove excess aggregate that is not embedded in the asphalt. **Final** brooming should be done as soon as the binder is fully cured: on the same day or the following morning. Best results are obtained by waiting until the following morning (as early as possible). Temperatures are lower during the early hours and the aggregate will be held more firmly in place with only the excess aggregate removed.

#### Equipment

The only equipment needed is a rotary broom or a vacuum sweeper for curbed roadways. One or two pickup trucks may accompany the broom, especially if there is a high volume of traffic. One truck may lead and the other follows the sweeper as a warning to traffic. Pickup trucks and sweepers must have appropriate warning devices.

#### Procedures

The sweeper should begin at the centerline and sweep the aggregate toward the outside edge of the roadway. It is always best to broom excess aggregate away from traffic. Regardless of how many passes are required, the objective is to broom the excess aggregate off the roadway surface.

#### Inspection

Ensure that all excess aggregate is removed from the roadway surface including intersections. Extra brooming may be required at the transverse joints where aggregate tends to overlap. Care should be taken to ensure that large quantities of aggregate are not swept onto adjacent private property. In addition, the operation should be carefully observed to assure that the sweeper is not dislodging aggregate that is embedded in the binder. Also ensure that sweeping is performed safely and with minimum interruption or delay of traffic.

## Section 19

### Opening to Traffic

#### Introduction

Traffic should be kept off the fresh seal coat as long as possible. This section discusses the various factors that can affect when it is appropriate to open the seal coat to traffic.

#### Traffic Volume

Roadways with a low-traffic volume may be opened to traffic sooner than high-traffic volume roadways.

#### Truck Traffic

On roadways with a high volume of truck traffic, hot asphalt needs longer to cool (and stiffen) and emulsions need longer to cure so that trucks will not damage the surface.

#### Traffic Speed

When sealing roadways where traffic speeds are high, it is best to allow additional time for asphalt to bond to the aggregate securely prior to opening to traffic. This not only prevents damage to the freshly placed seal coat but also reduces the potential for vehicle damage.

Allowing slow-moving traffic on a new seal coat after final rolling is one of the best means to reduce premature aggregate loss. Slowly moving vehicles seem to provide a level of aggregate orientation not achievable by conventional pneumatic rollers. One method to assure the traffic will move slowly is to use pilot vehicles.

#### Asphalt Type and Weather Conditions

The type of asphalt binder used will affect the amount of time prior to opening the lane to traffic.

**Asphalt Cement.** Asphalt cements stiffen sooner and bind the aggregate with greater tenacity than asphalt emulsions, and thus may be opened to traffic sooner.

**Asphalt Emulsions.** Emulsions are typically shot at about 150°F which is near the pavement temperature during the summer, so there is little loss of binder temperature. However, high humidity requires more time for emulsions to break. When humidity is greater than 50 percent, traffic should be kept off the seal as long as possible.

If it rains and emulsions are in use, traffic must be kept off the fresh seal or it is likely that most of the aggregate and much of the binder will be lost.

### **Changing Lanes**

When a lane is finished and it is time to turn traffic onto the fresh seal, extreme care must be taken to avoid confusion and ensure the safety of motorists and construction personnel. The critical issue is that complete and positive control is exercised over the traffic, movement of equipment onto the opposite side, and the resetting of traffic cones.

## **Section 20**

### **Temporary or Permanent Pavement Markings**

#### **General**

When the seal coat is applied, the center stripe and lane markings are obliterated. For the safety of motorists, markings must be replaced as quickly as possible.

#### **Temporary Markings**

Temporary tabs should be placed before the seal coat operation begins and the covers removed from the tabs as soon as possible after the rollers have finished or no later than the end of the day. When the adjacent lane is to be sealed on a different day, use tabs with double covers to prevent the need to apply a second set of tabs.

#### **Permanent Markings**

The roadway must have permanent markings applied within the time frame specified on the plans. Temporary markings must be removed after placement of permanent markings.

## Section 21

### Placing Raised Pavement Markers

#### General

Temporary tabs, which were placed prior to shooting the asphalt, should be removed and raised pavement markers should be installed. The surface should be free of dirt, grease, oil, moisture, or loose aggregate prior to marker installation.

## **Section 22**

### **Cleanup**

#### **Joint Paper**

The paper used for the construction of transverse joints must be collected from the side of the road for proper disposal.

#### **Spilled Asphalt**

Sometimes small quantities of asphalt are inadvertently spilled where distributors were loaded and around the heater units. Any spilled asphalt should be removed and disposed of properly.

#### **Stockpile Area**

All excess aggregate at the stockpile area must be removed. Any trash must also be removed, and the area should be left in a condition acceptable to TxDOT.

#### **Signs and Barricades**

All warning signs and barricades used on the project must be removed from the area after the project has been accepted. Ensure all construction sign supports are completely removed to avoid future tire damage.

#### **Repairs to Damaged Property**

Carefully inspect the areas around stockpiles and any other area where equipment has been used. Fences, mailboxes, and other private property should be inspected for damage and any damages must be repaired.

# Chapter 9

## Public Perception and Complaints

### Contents:

[Section 1 — Handling Complaints](#)

[Section 2 — Public Perception and Education](#)

## Section 1

### Handling Complaints

#### General

All complaints should be documented and handled in a courteous, professional, and timely manner. The following typical complaints may come from the public during or after placement of a seal coat or surface treatment:

- ◆ Vehicle damage from loose aggregate
- ◆ Asphalt on vehicles.

During contract seal coat work, any complaints of the above nature should be directed to the contractor. During the preconstruction meeting, a phone number should be obtained from the contractor to answer these types of complaints. After contract seal coat work is completed, these complaints should be handled by the local TxDOT office.

If the seal coat work is being performed by state forces, each complaint should be investigated on an individual basis by the appropriate district personnel. If action is necessary, it should be handled in a timely manner.

For complete TxDOT policy and procedure for handling complaints, see [Chapter 2, Section 5](#) of the Occupational Safety Manual.



## Section 2

### Public Perception and Education

#### General

Seal coats and surface treatments are used extensively in Texas, and the traveling public should be accustomed to this type of pavement surface. It is important for the public to understand why seal coats are critical for the preservation of the highway system. Occasionally someone may complain that they simply do not like this type of surfacing. The public may complain about this type of surfacing due to tire-pavement noise, loose rock, or the perception that it is inferior to an asphalt concrete overlay. Any complaint requires a response that addresses the concerns and also serves to educate the public regarding seal coats. It is important to communicate and coordinate with the district's Public Information Office so they can help address complaints and educate the public.

Certain complaints may need to be addressed by a written response. The following is an example of a response from an area engineer to a citizen complaining of loose rock, does not think the seal coat is an adequate pavement surface, and is requesting that TxDOT overlay the surface.

“I am the TxDOT Area Engineer responsible for the highway section in question. I have asked our Maintenance Section to investigate any loose rock on this section of roadway and sweep where needed.

“In TxDOT, we refer to this type of surfacing as a seal coat. It consists of placing a thin layer of asphalt on the pavement and covering it with a single layer of rock. The asphalt seals most cracks (minimizing moisture infiltration) in the existing pavement and provides a binder for the rock. The rock provides a new friction course for the traveling public.

“This operation is very cost effective and is the most utilized preventive maintenance treatment on the Texas state highway system. Preventive maintenance treatments are used throughout the nation to preserve pavements and extend their useful performance life. Preventive maintenance treatments on the state highway system are generally constructed with funding from the Preventive Maintenance Program. Since funding under the Preventive Maintenance Program is limited, this funding is allocated to provide the most cost-effective treatment for each highway. A seal coat typically costs about \$1.00/square yard; whereas, an asphalt concrete overlay costs about \$5.00/square yard.

“We will continue to evaluate and prioritize work on all of the highways. As conditions warrant and funding becomes available, we will continue to use cost-effective methods to preserve the pavement structure on this highway.

“Our maintenance forces will continue to inspect this roadway and take appropriate corrective action, as needed. In some cases, the loose rocks are ones that have just lost their embedment into the asphalt and are immediately whipped from the travel lanes by traffic. Unfortunately, these rocks sometimes come in contact with a vehicle before ending up in

the ditch. When this is the case, there may be no obvious signs of loose rock when our forces go out to inspect.

“Thank you for your concern with the safety of Texas highways and feel free to contact me with any additional concerns.”